



European Network of
Transmission System Operators
for Electricity

NETWORK CODE FOR REQUIREMENTS FOR GRID CONNECTION APPLICABLE TO ALL GENERATORS

REQUIREMENTS IN THE CONTEXT OF PRESENT PRACTICES

26.06.2012

WORKING DOCUMENT

1	OVERVIEW	3
2	FREQUENCY RANGES	4
2.1	UNLIMITED TIME OPERATION: 49-51 Hz	6
2.2	TIME LIMITED OPERATION: 47.5-51.5 Hz	6
3	(LIMITED) FREQUENCY SENSITIVE MODE	15
3.1	FREQUENCY SENSITIVE MODE	15
3.2	LIMITED FREQUENCY SENSITIVE MODE – OVERFREQUENCY	18
3.3	LIMITED FREQUENCY SENSITIVE MODE – UNDERFREQUENCY	19
4	MAXIMUM ACTIVE POWER OUTPUT REDUCTION AT UNDERFREQUENCY	22
5	VOLTAGE RANGES.....	25
6	FAULT-RIDE-THROUGH	31
6.1	SCOPE	31
6.2	WHAT IS THE FRT CAPABILITY ABOUT AND WHY IS THERE A THE POSSIBILITY FOR SUCH A LONG TIME AS 250MS?	31
6.3	WHY SHOULD FRT REQUIREMENTS BE EXTENDED TO SMALLER UNITS?	32
6.4	ACER’S FRAMEWORK GUIDELINES ON FRT	33
6.5	CLASSIFICATION OF FRT RELATED REQUIREMENTS	33
6.6	HOW DO THE REQUIREMENTS OF NC RFG RELATE TO PRESENT REQUIREMENTS THROUGHOUT EUROPE?34	
6.7	EXTRACTS FROM NATIONAL CODES.....	34
6.7.1	AUSTRIA	35
6.7.2	FINLAND	35
6.7.3	HUNGARY	36
6.7.4	SWITZERLAND	37
6.7.5	ITALY.....	37
6.7.6	POLAND	39
6.7.7	SPAIN	39
6.7.8	SWEDEN.....	41
6.7.9	NORWAY	42
6.7.10	PORTUGAL	42
6.7.11	GREAT BRITAIN.....	43
6.7.12	BELGIUM	44
7	REACTIVE POWER CAPABILITY	45

1 OVERVIEW

This document is closely linked to the document “NC RfG - Justification Outlines”, which is published as one of the supporting documents of the final network code on “Requirements for Grid Connection applicable to all Generators”.

The justification outlines explain the motivation for formulating requirements in the NC RfG as either exhaustive or non-exhaustive, and in addition why some requirements provide data/ranges while others prescribe mere principles.

For the non-exhaustive requirements, most often a reference to Art. 4(3) is made which implies a decision at the national level within a framework according to the national legislation. This framework will likely include a request for a proper justification in a given format.

The aim of this document is to illustrate how exhaustive requirements and some of the non-exhaustive, mandatory requirements of the NC RfG relate to present practices throughout Europe. The selection of requirements is to be seen in light of comments received during the network code development process of the last years. It is emphasized that most of the reference provided in this document refer to transmission grid codes throughout Europe, but is in this context not exhaustive in itself.

2 FREQUENCY RANGES

Art. 8(1)a of the NC RfG prescribes the following:

- 1) A Power Generating Module shall be capable of staying connected to the Network and operating within the Frequency ranges and time periods specified by Table 2
- 2) While respecting the provisions of Article 4(3), wider Frequency ranges or longer minimum times for operation can be agreed between the Relevant Network Operator in coordination with the Relevant TSO and the Power Generating Facility Owner to ensure the best use of the technical capabilities of a Power Generating Module if needed to preserve or to restore system security. If wider Frequency ranges or longer minimum times for operation are economically and technically feasible, the consent of the Power Generating Facility Owner shall not be unreasonably withheld.
- 3) While respecting the provisions of Article 8(1) (a) point 1) a Power Generating Module shall be capable of automatic disconnection at specified frequencies, if required by the Relevant Network Operator. While respecting the provisions of Article 4(3), Terms and settings for automatic disconnection shall be agreed.

The capability of keeping Power Generating Modules operating during deviations of system frequency from its nominal value is of crucial importance from the perspective of system security. Significant deviations are likely to occur in case of a major disturbance to the system, which comes along with splits of normally synchronously interconnected areas due to imbalances between generation and demand in the then separated parts of the system. A rise of frequency will occur in case of generation surplus, while lack of generation will result in a drop of frequency. The volume of a frequency deviation not only depends on the amount of imbalance, but also on other conditions / characteristics of the system, such as the generation profile, system inertia, spinning reserve and the frequency response speed.

Synchronous Area	Frequency Range	Time period for operation
Continental Europe	47.5 Hz – 48.5 Hz	To be defined by each TSO while respecting the provisions of Article 4(3), but not less than 30 minutes
	48.5 Hz – 49.0 Hz	To be defined by each TSO while respecting the provisions of Article 4(3), but not less than the period for 47.5 Hz – 48.5 Hz
	49.0 Hz – 51.0 Hz	Unlimited
	51.0 Hz – 51.5 Hz	30 minutes
Nordic	47.5 Hz – 48.5 Hz	30 minutes
	48.5 Hz – 49.0 Hz	To be defined by each TSO while respecting the provisions of Article 4(3), but not less than 30 minutes
	49.0 Hz – 51.0 Hz	Unlimited
	51.0 Hz – 51.5 Hz	30 minutes
Great Britain	47.0 Hz – 47.5 Hz	20 seconds
	47.5 Hz – 48.5 Hz	90 minutes
	48.5 Hz – 49.0 Hz	To be defined by each TSO while respecting the provisions of Article 4(3), but not less than 90 minutes
	49.0 Hz – 51.0 Hz	Unlimited
	51.0 Hz – 51.5 Hz	90 minutes
	51.5 Hz – 52.0 Hz	15 minutes
Ireland	47.5 Hz – 48.5 Hz	90 minutes
	48.5 Hz – 49.0 Hz	To be defined by each TSO while respecting the provisions of Article 4(3), but not less than 90 minutes
	49.0 Hz – 51.0 Hz	Unlimited
	51.0 Hz – 51.5 Hz	90 minutes
Baltic	47.5 Hz – 48.5 Hz	To be defined by each TSO while respecting the provisions of Article 4(3), but not less than 30 minutes
	48.5 Hz – 49.0 Hz	To be defined by each TSO while respecting the provisions of Article 4(3), but not less than the period for 47.5 Hz – 48.5 Hz
	49.0 Hz – 51.0 Hz	Unlimited
	51.0 Hz – 51.5 Hz	To be defined by each TSO while respecting the provisions of Article 4(3), but not less than 30 minutes

Table 2: Minimum time periods for which a Power Generating Module shall be capable of operating for different frequencies deviating from a nominal value without disconnecting from the Network.

Figure 4 to Figure 7 show a set of present applicable practices in Europe on required frequency range capabilities. These practices are based on either the applicable transmission grid code or on common prescriptions in bilateral contracts with Power Generating Facility Owners. This overview reveals that a common ‘standard’ in Europe in frequency range requirements does not exist at present. Currently, frequency range

requirements differ widely across TSOs in particular in terms of ranges and time periods where time-limited operation of power generating modules is required. The graphics show the existing requirements (colored) compared to NC RfG requirement (grey). It can be concluded from these diagrams that currently less onerous frequency range requirements as well as more onerous requirements are established. In any case, the diagrams show that the frequency range requirements of NC RfG do not introduce new provisions, which do not exist in current requirements at all.

The difference between the NC RfG and the national code requirements cannot be related to a particular range in frequency or time period. However, due to their direct cross-border impact, frequency requirements have to be reasonably as much as possible harmonized on a synchronous area level. Because currently frequency range requirements in each national grid code are different, it is not possible to identify a common base for a systematic deviation of the NC RfG from existing practices. The NC RfG frequency range requirements have been elaborated by making a comparison between the European best practices, identifying the best technical compromise in order to allow for an appropriate time with security time margins to recognize emergency situations and to respond by best defence actions in a system operating closer and closer to its limits.

2.1 UNLIMITED TIME OPERATION: 49-51 Hz

The frequency range requirements of the NC RfG are in the range of many currently existing national requirements regarding unlimited time operation. The results furthermore reveal the absence of any existing European standard in the current national requirements, which could be considered as a baseline for identification of deviations. Moreover, a conclusion when assessing the overview of present requirements is that no significant deviation from current practices exists.

In addition it needs to be emphasized that the time-unlimited operation in the range of 49 – 51 Hz as required by the NC RfG is compliant to an international standard for rotating electrical machines established by IEC 60034.

Compliance of the NC RfG with international practices for time unlimited operation has been acknowledged in stakeholder meetings¹.

2.2 TIME LIMITED OPERATION: 47.5-51.5 Hz

Frequency excursions below 49 Hz and above 51 Hz today are very rare and associated to extreme circumstances but are expected to be more frequent and last longer with conditions creating uncertainties for timely system recovery due to more intermittent generation, changes in system inertia, changes in demand patterns (smart grids), more dispersed generation connected to DSO networks, etc. Deviations of frequency from its nominal value due to load imbalances therefore occur everywhere at the same time and affect all power generating modules immediately in a common way regardless of their size and voltage level of connection. Therefore, common ranges and time periods of time-limited operation of power generating modules are indispensable, while taking into account regional characteristics of the network, the existing portfolio and the network operators' operational requirements.

¹ Outcome of Stakeholder meetings are accessible at <https://www.entsoe.eu/resources/network-codes/requirements-for-generators/>, most notably in this respect are:

- 20 Dec. 2012: EUTurbines – Eurelectric WG Thermal – VGB Powertech
- 02 May 2012: 2nd RfG User Group meeting

The IEC 60034 on rotating electrical machines does provide a range of 47.5-51.5 Hz to be sustained for a limited time period without prescribing specific time periods. As such, NC RfG is also compliant for time-limited operation towards this international standard.

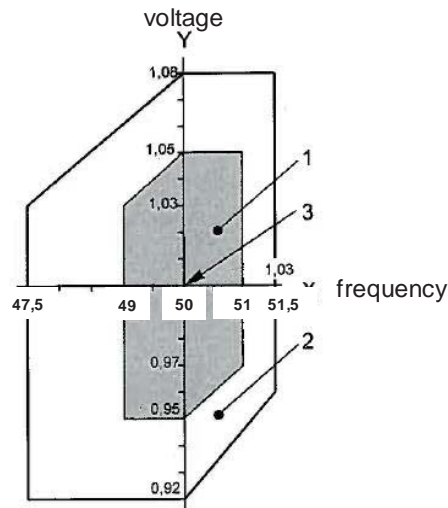

Area 1: Operation unlimited in time
 Area 2: No specification of time limits

FIGURE 1 - FREQUENCY AND VOLTAGE RANGES FOR OPERATION OF ROTATING ELECTRICAL MACHINES ACCORDING TO IEC STANDARD 60034-1

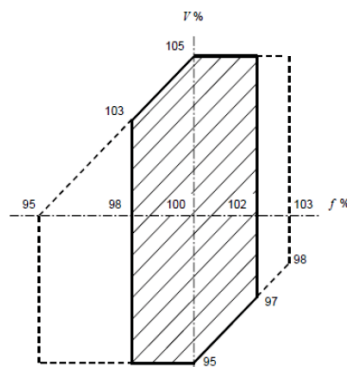

FIGURE 2 - FREQUENCY AND VOLTAGE RANGES FOR OPERATION OF SYNCHRONOUS GENERATORS DRIVEN BY STEAM TURBINES OR COMBUSTION GAS TURBINES ACCORDING TO IEC STANDARD 60034-3

Further information on the link between the NC RfG frequency range requirement and the IEC 60034 standard is provided in the “NC RfG – Frequently Asked Questions”²

² Published (Jul.2011) as supporting documentation of the ENTSO-E pilot code and subsequently updated to support the draft code published for consultation (Jan. 2012) and the final Network Code (Jun. 2012)

The argumentation for the time ranges applied in present European practices and which are in line with NC RfG is based on the following actions in case of an emergency situation:

- Recognize the situation;
- Establish plan of actions;
- Implement plan;
- Security time margin.

In this situation a network operator has several tools at its disposition to deal with the situation:

- Monitor System States including state estimation applications;
- Means for controlling of switching;
- Communication between control centers of TSOs - DSOs, Generating Facilities and Demand Facilities, for balancing, ancillary services, system defense and restoration and for the delivery and coordination of real-time operational data;
- Tools for security analysis.

It is noted that other emergency measures are activated at 49 Hz (or sometimes even at higher frequencies), most notably demand disconnection³.

The NC RfG, like other national codes at present, ensure that ensure that Network Operators have adequate time to respond to emergencies in a system operating closer and closer to its limits. The NC RfG aims at achieving this goal in the most proportionate, non-discriminatory manner across Member States within a synchronous area.

The rationale for the longer 90 minutes time frame in the GB area for 47.5-48.5 Hz was the result of a recent public consultation⁴.

³ ENTSO-E, Technical background and recommendations for defence plans in the Continental Europe synchronous area, January 2011 - <https://www.entsoe.eu/resources/publications/system-operations/https://www.entsoe.eu/resources/publications/system-operations/>

⁴ <http://www.nationalgrid.com/uk/Electricity/Codes/gridcode/consultationpapers/2010/> (section D/10)

“The 90 minute system restoration time was proposed during the recent work of the E3C Small Generators Frequency Obligation Working Group. It had been derived from the maximum estimated time that NGET would take to react to extreme system events. Expressed in general terms, this breaks down to 30 minutes to establish conditions and develop a plan, 30 min to implement plus a 30 min safety margin to cover additional inherent complexity and uncertainty. NGET did not believe this duration could be reduced without introducing significant risk of being unable to ensure system restoration. The Working Group agreed that the proposed 90 minute limit is appropriate”

Continental Europe

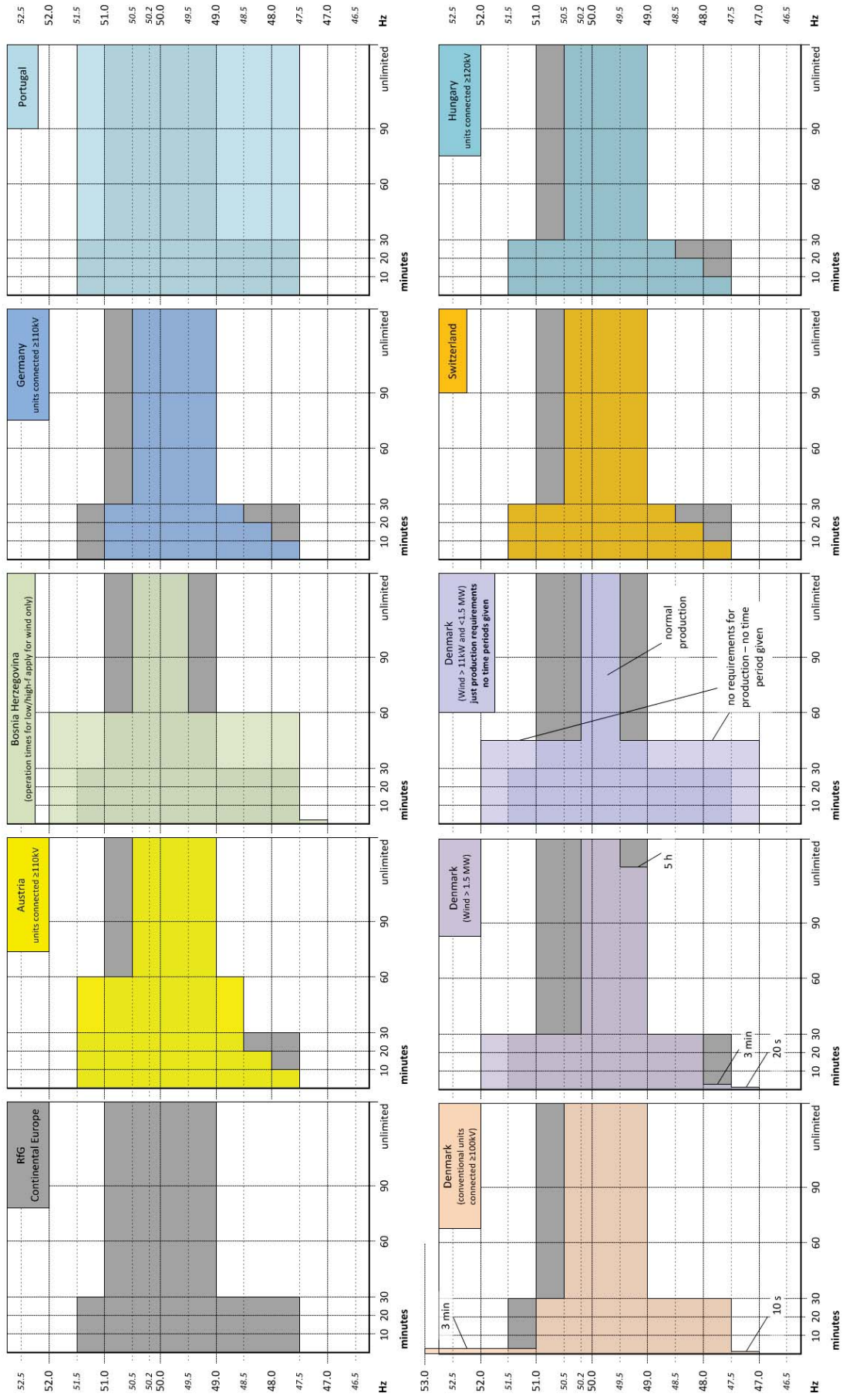

FIGURE 3 - OVERVIEW OF FREQUENCY RANGE REQUIREMENTS IN CONTINENTAL EUROPE FOR SELECTED COUNTRIES (I)

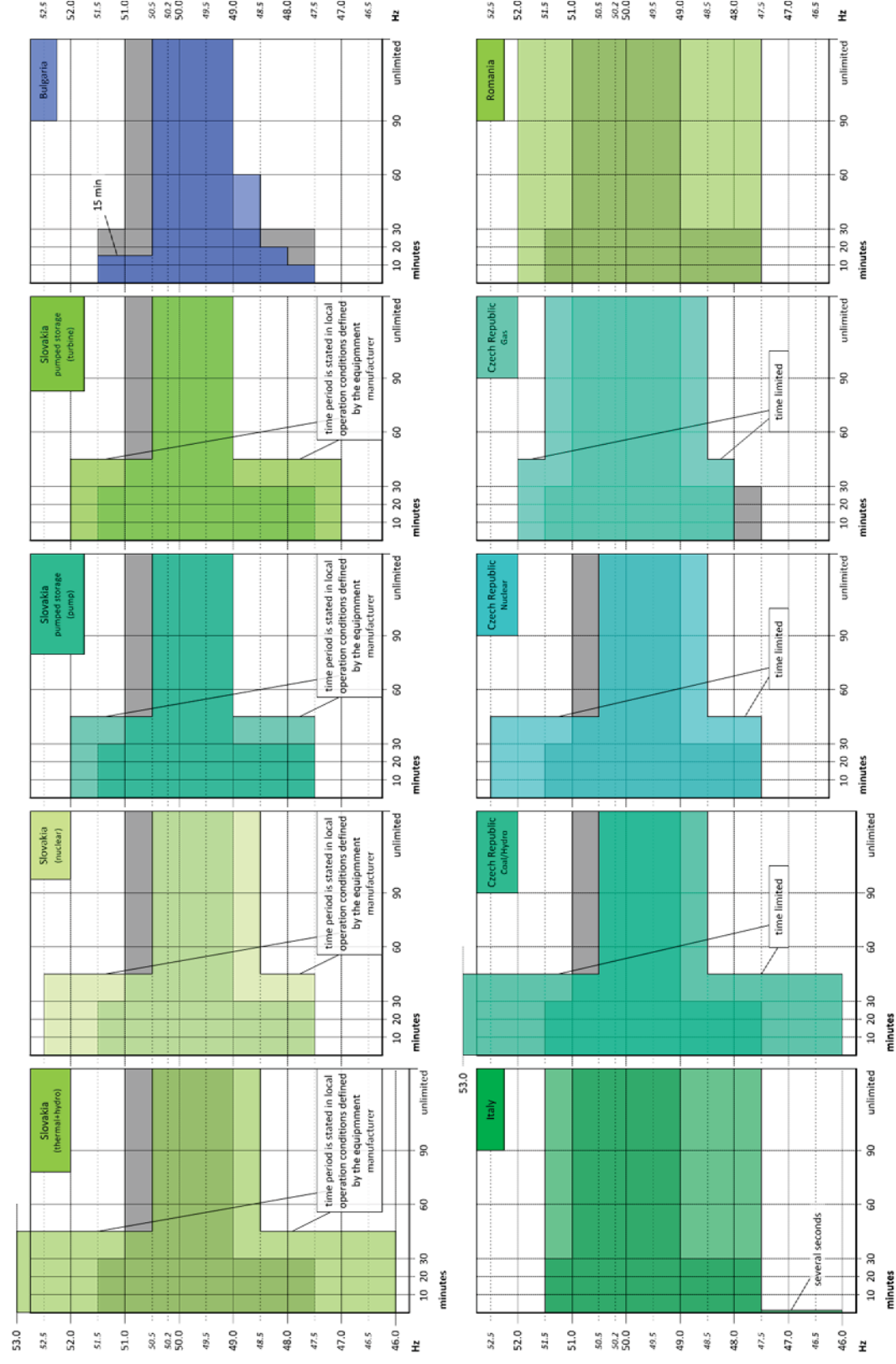

FIGURE 4 - OVERVIEW OF FREQUENCY RANGE REQUIREMENTS IN CONTINENTAL EUROPE FOR SELECTED COUNTRIES (II)

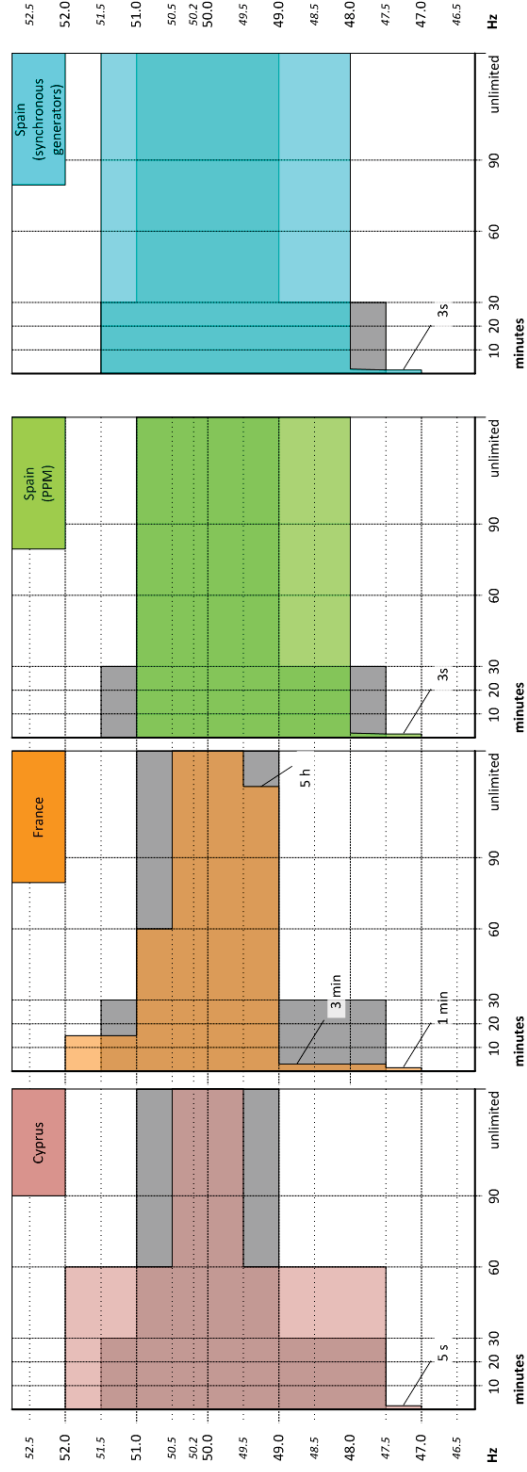
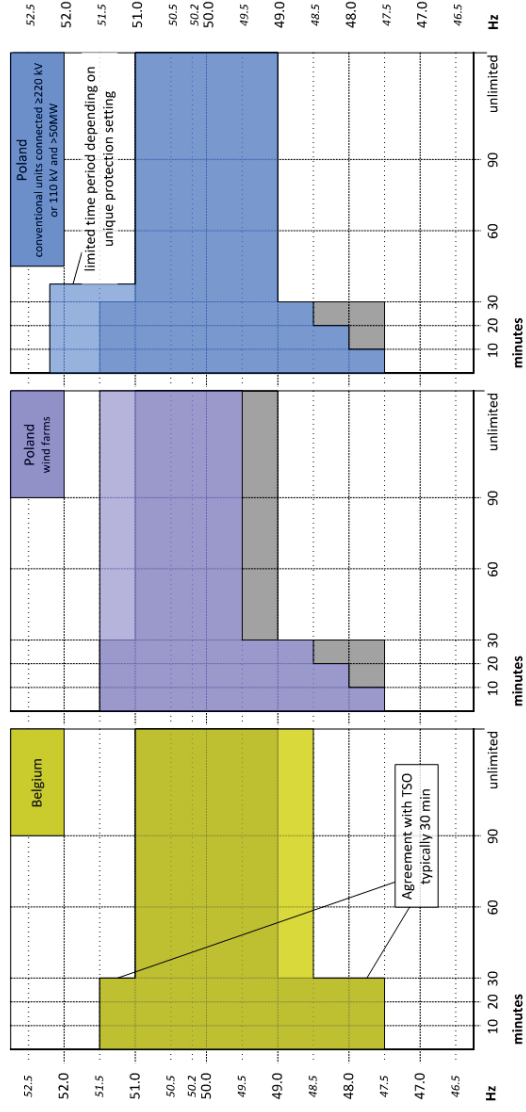

FIGURE 5 - OVERVIEW OF FREQUENCY RANGE REQUIREMENTS IN CONTINENTAL EUROPE FOR SELECTED COUNTRIES (III)

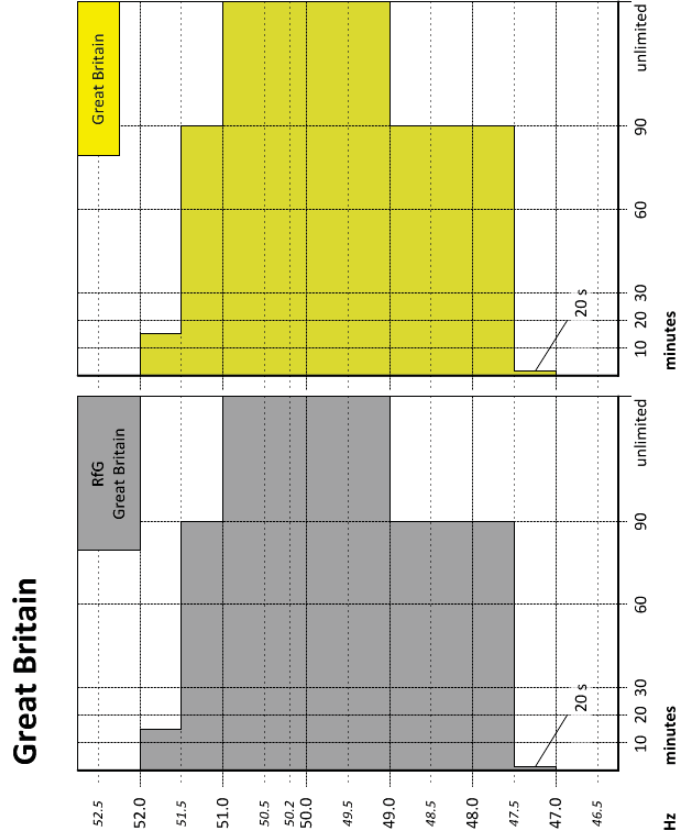

FIGURE 6 - OVERVIEW OF FREQUENCY RANGE REQUIREMENTS IN GREAT BRITAIN

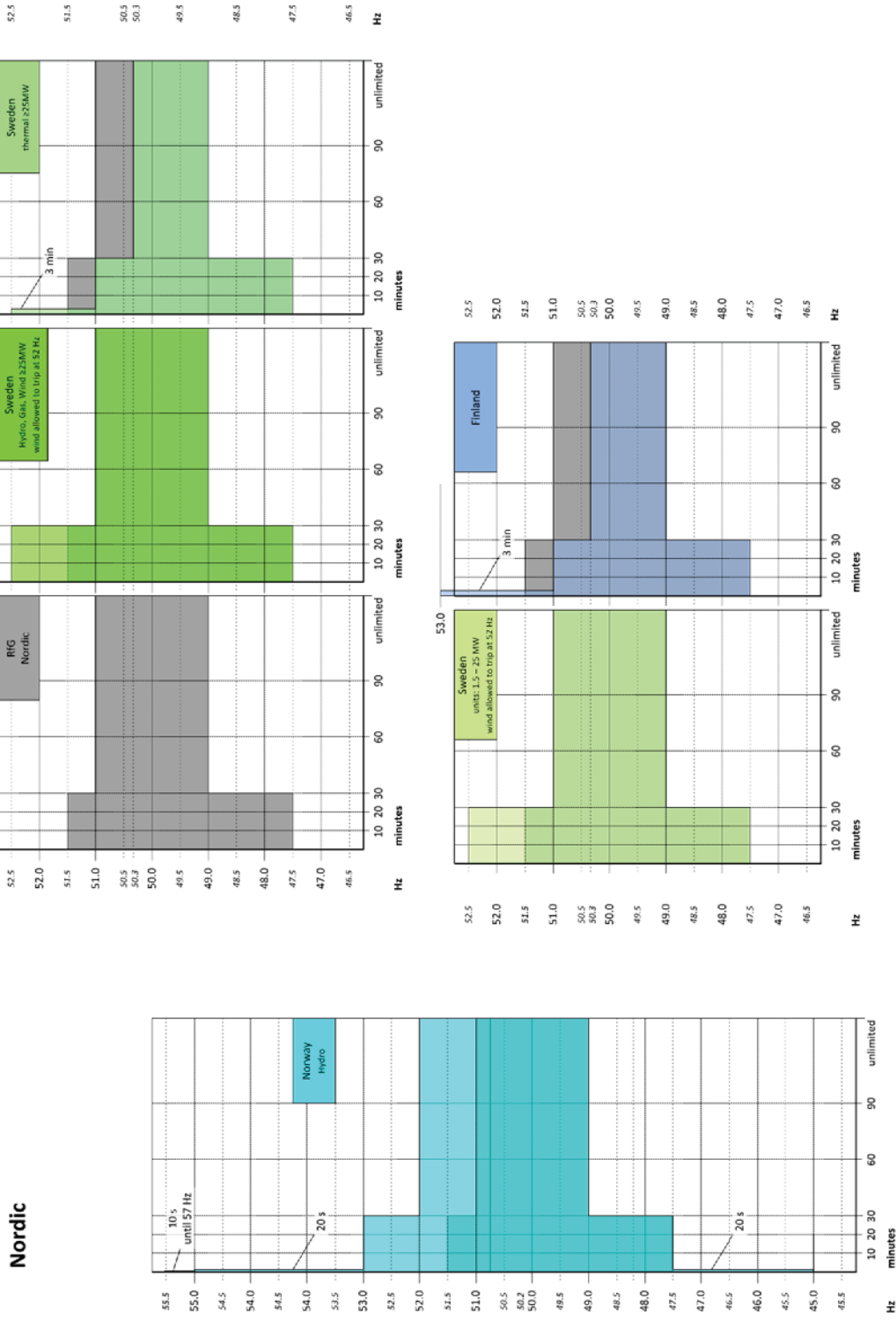

FIGURE 7 - OVERVIEW OF FREQUENCY RANGE REQUIREMENTS IN THE NORDIC REGION

Conclusion

- Compared to present practices across Europe, the NC RfG frequency range requirements are not the present least onerous requirements, nor across the most onerous ones.
- The ranges are compliant with IEC 60034 on rotating electrical machines.
- The periods for limited time duration are needed for a network operator to take appropriate measures in case of severe system events.
- The proposed ranges are proportionate considering present practices and expected changes in the decades ahead, as well as non-discriminatory across Member States within a synchronous area.

for Electricity

3 (LIMITED) FREQUENCY SENSITIVE MODE

3.1 FREQUENCY SENSITIVE MODE

The purpose of the Frequency Sensitive Mode (FSM) requirement is for a generator to have the capability of providing an automatic response to changes in frequency in order to contribute to the containment and correction of the system frequency. The actual procurement of the service is out of the scope of this code⁵.

Generators in the scope of the NC RfG are required to have the capability to provide frequency response, according the following FSM parameter settings:

Parameter	Range	
Power Range related to max capacity (deltaP/Pmax)	1,5 10	%
Frequency Response Insensitivity	10 30	mHz
Frequency Response Deadband	0 500	mHz
Droop	2 12	%
Max admissible initial delay t1	2	sec
Max admissible choice of full activation t2	30	sec
Providing period/time	15 30	min

Most TSOs in Europe have a regime in line with the FSM principles. Many of them are in line with the FSM requirement as prescribed in the NC RfG as can be seen in the following Table.

Country	Present practice
Germany	Currently covered in the transmission code 2007: Active power +/- 2%, droop decided by TSO, deadband individually decided.
Austria	The FSM requirement is covered. No obligation currently in national grid code. Units ≥ 110 kV: Prequalified generators (tendering for primary control) for frequency deviations +/- 200 mHz pursuant to OH UCTE. Units ≥ 25 MW contribute to primary control for frequency deviations pursuant OH UCTE.

⁵ For a link between the need for mandatory capabilities and delivery of services, see the ENTSO-E paper “NC RfG in view of the future European electricity system and the Third Package network codes”

Latvia	Requirement currently covered
Czech	Presently covered by national grid code with FSM is referred to as primary frequency contract. deltaP/Pmax = 5%, Droop = 8%, Deadband = 0
Cyprus	Covered currently, except PPM
Estonia	Currently covered
Belgium	FSM is only activated for units participating to active primary control. Technical requirements not given in code, but in contract for delivery. The parameters are within the range of the NC RfG.
Denmark	Currently covered in national grid code. Technology based requirements: micro generators, thermal and wind power plants. Synchronous units above 10 MW already fulfill requirements today. Wind power parks above 25 MW already fulfill requirement today. Deadband, droop and frequency settings for wind power > 25 MW: dynamic configurable with a default value by regulations TF 3.2.5:2010 annex 4. Reconfigurable by on-line communication.
Finland	Current national requirements differ depending on energy source. Normal: Hydro + gas turbines: power response rate +/- 40% within 60 sec, if initial 40-100%. Other types: +/- 5% within 60 sec if initial 60-90% Disturbances: Hydro and gas turbines instantaneous power step change of 10% in the range of 50-100%. Other types at least 5% in the range of 50-90%. Droop: 2-8%. Dead-band: 0,05 Hz.
Greece	Minor changes; - article 241 of grid code foresees this requirement for conventional generators >100MW
Iceland	Currently not covered in the national grid code
Hungary	Voltage dependent - not power related. Only deltaP/Pmax for units \geq 120 kV, droop = 5%, no dead band
GB	Generators (including PPM and DC converts) if operating in FSM mode: deltaP/Pmax = 10%. Droop 3-5%, and deadband \leq 0.03 Hz. More details in Connection conditions.
Bosnia & Herzegovina	Currently this is partly covered for wind power plant.
Poland	Type D conventional units, max power > 100 MW: Droop 2-8%, deltaP/Pmax=+/-5%. Wind farms not covered by the requirements for operating in FSM
Spain	Will require minor changes
Portugal	Generating units - excluding wind shall: deltaP/Pmax = 5% excl PPM, droop 3-8%. Currently covered

France	Currently covered by national grid code. RES is excluded.
Slovakia	No general rules for FSM in the Slovak TSO grid code. Conditions stated are according to rules for primary control: Min power regulation +/- 2% P _n (between 1-10 MW), deadband for frequency response is +/- 10 MHz
Norway	Minor changes; RfG has a Freq Response Insensitivity Range 10-30 mHz. The standard in Norway is 5-30 MHz Case dependent - depending on the location in the grid. Droop: 1-12%, deadband = 0
Sweden	Automatic frequency control is specified. NPP and PPM are excluded, and for below 25 MW. Gas turbines and hydropower > 25 MW: 0,25-04 pu power/Hz, frequency deviation +/- 200 mHz. +/- 10% within 30 sec in range 10-90%. Thermal power > 25 MW minus nuclear: 0,25-1 pu power/Hz, frequency deviation +/- 200 mHz. +/- 2% within 30 sec in range 40-90%. Regulating freq disturbances: >25MW, power step 2,5-30% within 5-30 sec, range 50-100%.
Switzerland	Currently covered, TC 2010
The Netherlands	Currently covered by the national grid code
Italy	Currently covered by national grid code +/- 1,5% for Mainland Italy + Sicily, while +/- 10% for Sardinia (and Sicily in island mode). No FSM for RES/PPM. Droop: 2-8%, 4% for hydro, 5% for thermal. Deadband: +/- 10 MHz for hydro, and +/- 10 or 20 mHz for thermal
Romania	Active power $\Delta P/P_{max} = 1,5\%$, droop 2-12%, deadband +/- 10 mHz.

Broadly speaking, differences with present practices result from the following:

- **FSM as requirements and not as connection contract rules:** Several TSOs base their FSM regime on the UCTE Operational Handbook, which states frequency response (primary control) to be delivered. The UCTE Operational Handbook (and similar handbooks) states as such not the capabilities, but the actual ancillary services to be delivered. In some countries the delivery is also purely market based. ENTSO-E's argumentation for requiring the mandatory technical capability for all type C units, irrespective of the eventual procurement is for the market to be able to deliver the services if needed in the decades ahead. A full argumentation is provided in the paper "NC RfG in view of the future European electricity system and the Third Package network codes"
- **Technology specific national codes vs. technology neutral NC RfG:** The NC RfG is as a main principle not technology-focused. Some countries nowadays exempt existing generating units for FSM based on technology/energy source, e.g. RES/PPM and nuclear power plants. Reasons for exemption could be technical and/or economic aspects, based on historical market/system conditions. Again, the

rapidly changing power system forces NC RfG to look ahead and take into account scenarios of large RES increase and different market structures compared to some decades ago.

- **Threshold values (MW) for FSM:** For some countries the present, national threshold values (MW) deviate to the NC RfG FSM requirement, based on the regional type B, C and D classifications. Also, some countries currently base their present frequency response requirement on voltage level and not power output level. Eventually, creating a proportionate, non-discriminatory level playing field across Europe inevitably results in some changes compared to present practices. Most TSOs consider this for FSM to be moderate.

3.2 LIMITED FREQUENCY SENSITIVE MODE – OVERFREQUENCY

The NC RfG requires in Art 8(1)c:

The Power Generating Module shall be capable of activating the provision of Active Power Frequency Response according to figure 1 at a Frequency threshold between and including 50.2 Hz and 50.5 Hz with a Droop in a range of 2 – 12 %. The actual Frequency threshold and Droop settings shall be determined by the Relevant TSO. The Power Generating Module shall be capable of activating Active Power Frequency Response as fast as technically feasible with an initial delay that shall be as short as possible and reasonably justified by the Power Generating Facility Owner to the Relevant TSO if greater than 2 seconds. The Power Generating Module shall be capable of either continuing operation at Minimum Regulating Level when reaching it or further decreasing Active Power output in this case, as defined by the Relevant TSO while respecting the provisions of Article 4(3).

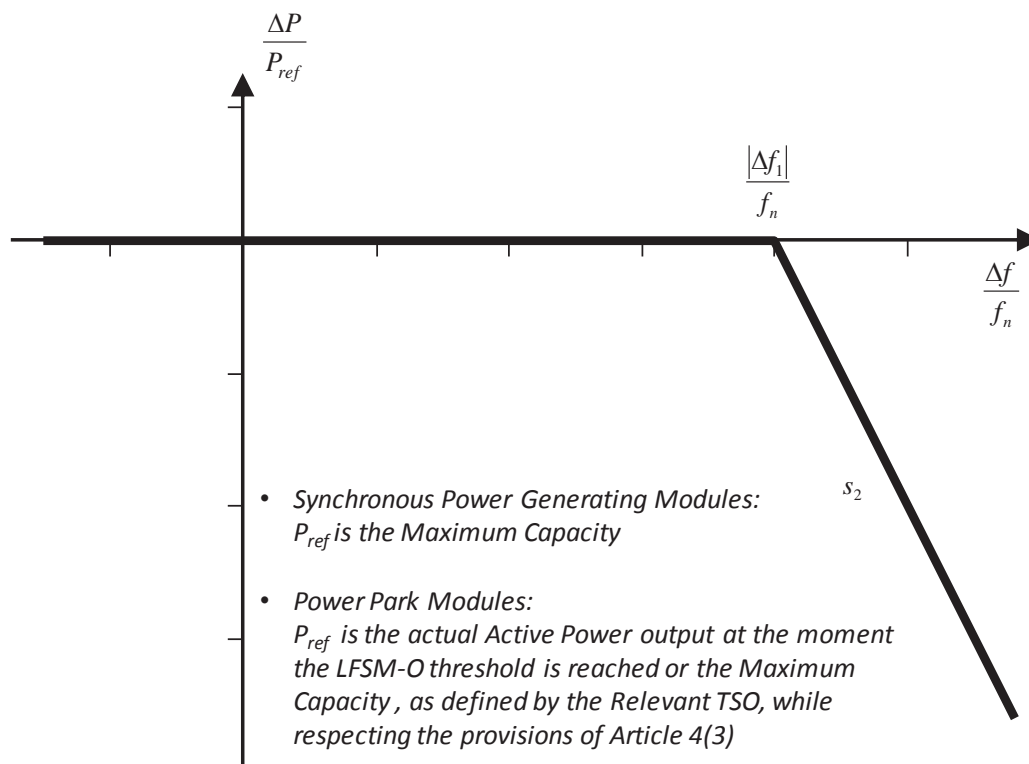

The NC RfG requirement on LFSM-O is in line with present practices in those countries that already require this capability or service, e.g. Germany, GB, Austria, Hungary, Slovakia, Czech, Poland, Italy, France.

Differences exist in terms of implementation for specific types (based on voltage or capacity threshold) or depending on a given technology. A main difference with present practices is the application of this requirement towards smaller users which is explained in the paper “NC RfG in view of the future European electricity system and the Third Package network codes”.

3.3 LIMITED FREQUENCY SENSITIVE MODE – UNDERFREQUENCY

The requirement of Limited Frequency Sensitive Mode at Underfrequency (LFSM-U) introduced by Article 10(2) (b) of the ENTSO-E Network Code for Requirements for Grid Connection Applicable to all Generators (NC RfG) is a new requirement for most European countries. Consequently there is no existing standard in practise against which this requirement could be evaluated for significant deviations. The further justification for implementing this requirement shall therefore focus on its need and its appropriateness.

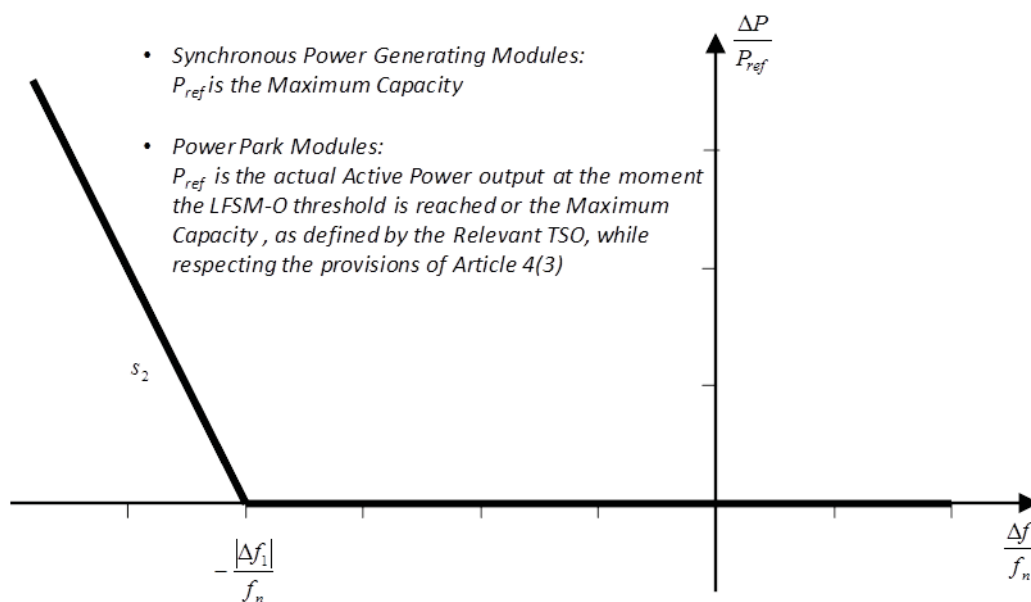

The objective of the LFSM-U requirement is to make available additional Active Power reserves in emergency situations at low frequencies when Active Power response provided by Power Generating Modules operating in Frequency Sensitive Mode is already exhausted, but before any load shedding. Such reserves can be provided by Power Generating Modules, which are operating at partial load and hence still have the possibility to increase generation proportionally to the deviation of frequency from its nominal value. To enable this capability, no additional investments in Power Generating Modules are needed, because it makes use of anyway existing control system features, e. g. proportional frequency (speed) control of synchronous Power Generating Modules. The performance is conditional to prime mover availability as well as reduced Maximum Active Power Output at low frequencies for certain generation technologies according to Article 8(1) (d) of the NC RfG.

This feature contributes to maintaining and restoring system security. It makes use of otherwise unused capabilities of Power Generating Modules running at partial load. It needs to be emphasized, that this requirement (like all others in the NC RFG) focuses on the technical capability of a Power Generating Module. No obligation to operate a Power Generating Module at a reduced load level is introduced herewith. One could say therefore, that it uses “coincidentally available” Active Power reserves, e. g. if a unit is not fully deployed due to market circumstances. It reduces the risk of frequency dropping further with consequential load disconnection and even major disturbances, at a relatively low cost.

Conclusion

- **Frequency Sensitive Mode is in line with most present practices throughout Europe nowadays.**
- **Limited Frequency Sensitive Mode – Overfrequency is in line with practices in those countries which already require this capability.**
- **Limited Frequency Sensitive Mode – Underfrequency is new to many countries. In terms of capability it provides a relatively low cost solution for aiming at avoiding the first stage of demand disconnection. The capability requirement puts no obligation on the conditions under which to procure this service (e.g. required available headroom or not).**

4 MAXIMUM ACTIVE POWER OUTPUT REDUCTION AT UNDERFREQUENCY

Art. 8(1)e of the NC RfG prescribes the following frequency stability requirement for all significant users (i.e. starting as of type A):

- a) The Relevant TSO shall define admissible Active Power reduction from maximum output with falling Frequency within the boundaries, given by the full lines in Figure 2:
 - Below 49 Hz falling by a reduction rate of 2 % of the Maximum Capacity at 50 Hz per 1 Hz Frequency drop;
 - Below 49.5 Hz by a reduction rate of 10 % of the Maximum Capacity at 50 Hz per 1 Hz Frequency drop.

Applicability of this reduction is limited to a selection of affected generation technologies and may be subject to further conditions defined by the Relevant TSO while respecting the provisions of Article 4(3).

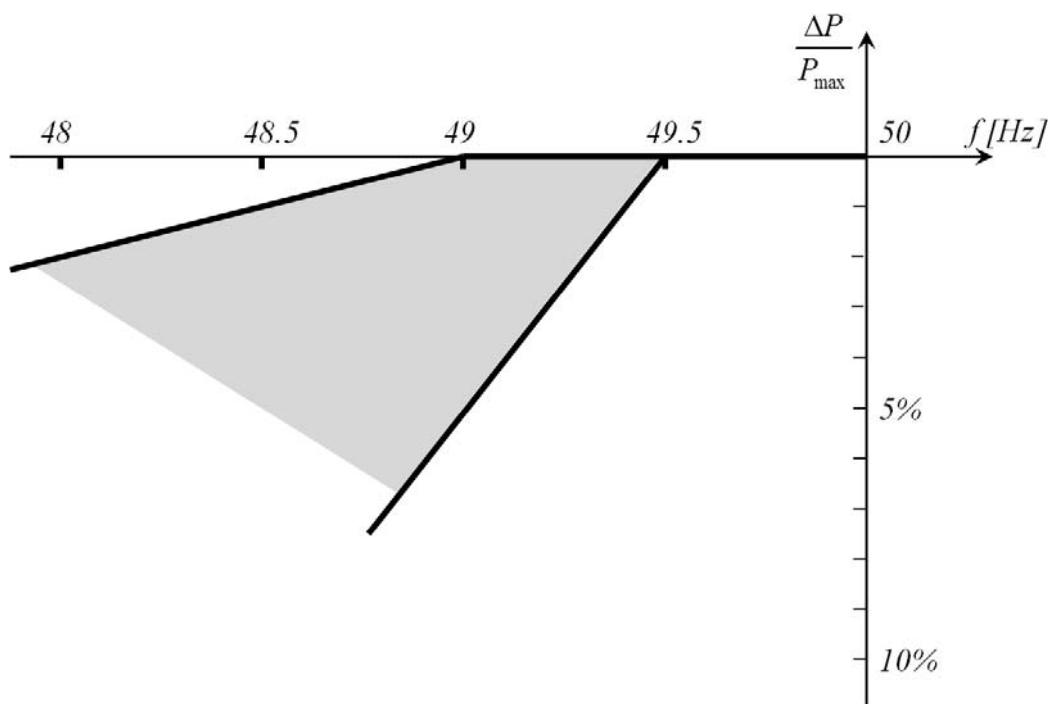

Rather than referring to this as a ‘requirement’ it can be seen as a relaxation for generators, especially certain technologies such as gas turbines where steam generation is coupled to the grid frequency. A lowered frequency results in a lower turbine rotational speed and as such a lower air mass inflow. To assure a stable combustion the fuel inflow is under most conditions reduced as well, resulting in a lower active power output of the plant.

As a connection requirement it may appear counterintuitive from a power system perspective where falling frequency indicates a shortage of generation (see also LFSM-U and FSM requirements).

Measures can be taken to mitigate the active power output drop, such as temperature increase, activation of water or steam injection through specific additional systems⁶. Much of the possible mitigation of this output drop depends on ambient conditions, most notably the ambient temperature. This makes it not straightforward to describe a detailed maximum active power output reduction ‘boundary’ which covers the most likely situations.

When analysing the present applicable practices throughout Europe a wide variety of ways to deal with this issue can be observed.

- Some countries have no prescriptions on this topic in the transmission grid code: e.g. Ireland, Portugal (up until 48.5Hz), Spain
- Some countries cover this as of a given threshold: e.g. Sweden (>1.5MW), Poland (as of type D generators)
- Some countries make distinctions based on technologies: e.g. Sweden
- Some countries cover this in bilateral agreements: e.g. Czech
- Some countries have this prescribed in their grid code, in line with the NC RfG ranges: e.g. France, Denmark, Germany, Finland, Hungary, Switzerland, GB.

Broadly speaking, the range prescribed in the NC RfG covers the requirement as implemented in small synchronous areas (GB), as well as in larger (Continental Europe), allowing for national variations (see below).

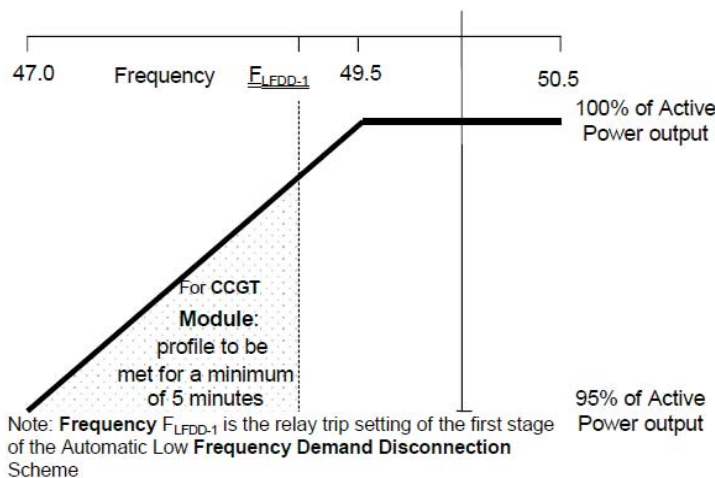

FIGURE 8 – GB IMPLEMENTATION

Figure 8 gives the GB situation at present. The GB Grid Code specifies requirements on Generators (including Power Park Modules and DC Converters) to limit their output with falling frequency as defined in CC.6.3.3. In summary 100% Active Power should be retained until 49.5Hz and Active Power should not then drop off by more than pro rata with frequency up to 47Hz, such that the maximum fall in Active Power output should be no less than 95% of Active Power Output at 47Hz as shown in the Figure.

⁶ See discussion in the 2nd RfG User Group meeting (02 May 2012)

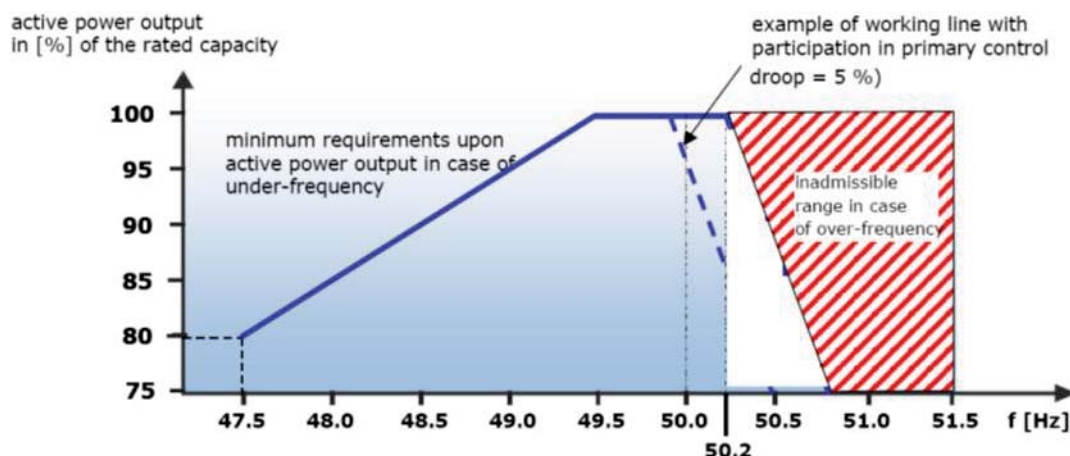

FIGURE 9 - GERMANY IMPLEMENTATION

Figure 9 gives the requirement as prescribed in the German Transmission Code (2007) which gives a 49.5Hz cut-off and 10% reduction rate. Similar prescriptions are applicable in Switzerland and Hungary.

Some countries that prescribe this requirement in their grid code have 49Hz as the cut-off frequency beyond which continuous or time limited operation is required but a reduces maximum active power output allowed (e.g. Finland, Sweden).

The NC RfG expands this requirement down to the level of type A generators as this is a basic frequency related requirement which justifies this as a cross-border issue and for which it deserves the same rationale as the requirement on frequency ranges. In the draft NC RfG published for public consultation in Jan. 2012 this requirement was attributed to type C generators. Many stakeholders requested a shift of this requirement to type A units to bring clarity on this technical issue.

ENTSO-E acknowledges the strong dependency of ambient conditions on the technical feasibility of sustaining a maximum active power output reduction while mitigating the risk of accidental tripping. As it is out of the scope of this Network Code to settle all possible conditions all across Europe, the NC RfG clearly stipulates “Applicability of this reduction is limited to a selection of affected generation technologies and may be subject to further conditions defined by the Relevant TSO while respecting the provisions of Article 4(3).”

Conclusion

- **Maximum Active Power Output Reduction at Underfrequency needs to be addressed in order to mitigate frequency drops.**
- **The requirement needs to cover all generators based on its direct frequency stability impact and to be non-discriminatory.**
- **The ranges prescribed by the NC RfG give the general framework which is in line with grid codes where this is already clearly addressed.**
- **To assure stable operation of generators under the prescribed requirement more ambient conditions need to be defined. Due to the extent of detail a dependency on local conditions, the NC RfG prescribes to define these at national level.**

5 VOLTAGE RANGES

Art. 11(2) of the NC RfG prescribes for type D Power Generating Modules:

„While still respecting the provisions according to Articles 9(3) (a) and 11(3) (a), a Power Generating Module shall be capable of staying connected to the Network and operating within the ranges of the Network Voltage at the Connection Point, expressed by the Voltage at the Connection Point related to nominal Voltage (per unit), and the time periods specified by tables 6.1 and 6.2.“

Table 6.1 and 6.2 prescribe respectively the ranges (voltage/time) for connections from 110 kV up to 300 kV (excluded), and for connections from 300 kV (including) up to 400 kV.

The requirement's main objective is to ensure voltage stability. The relevance of voltage range requirements for type D generators in a European Network Code covering cross-border and market integration issues is clarified in the „NC RfG – Frequently Asked Questions“ as FAQ 20.

The figures below provide some examples of present voltage range connection requirements across Europe for the 400kV system. The red curve indicates the voltage ranges and time periods required by Art. 11 of the NC RfG.

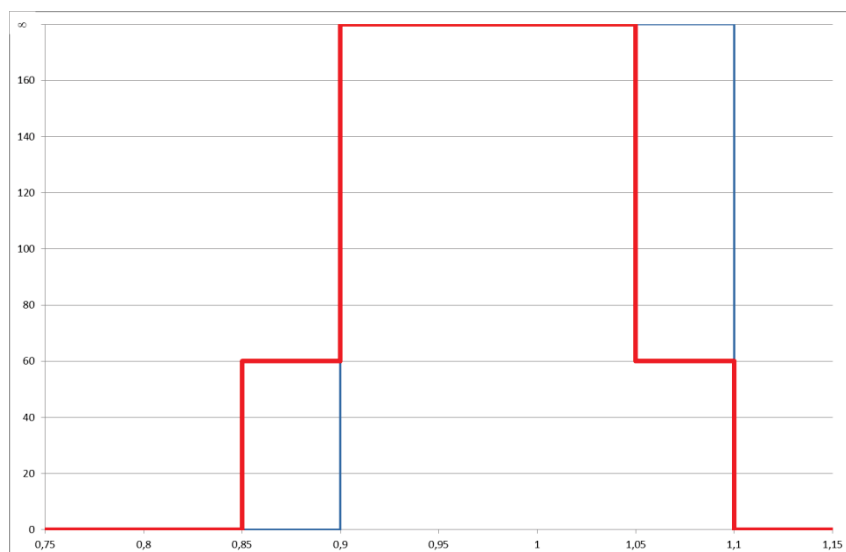

Figure 10 – Romania

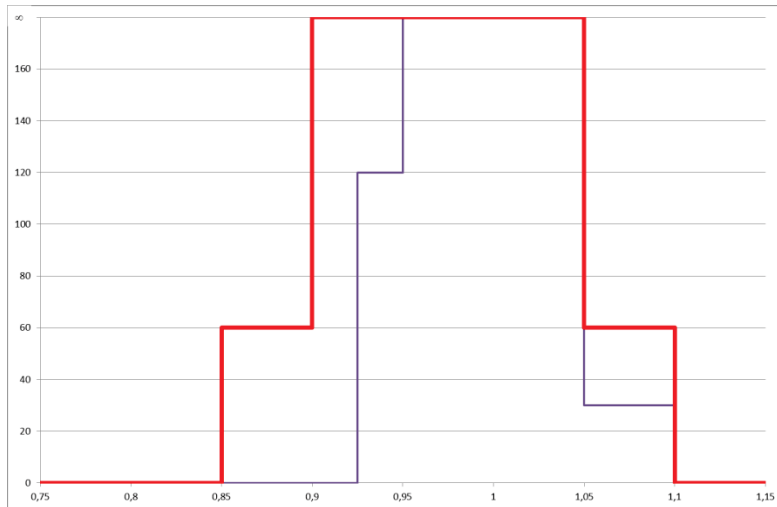

Figure 11 – Hungary

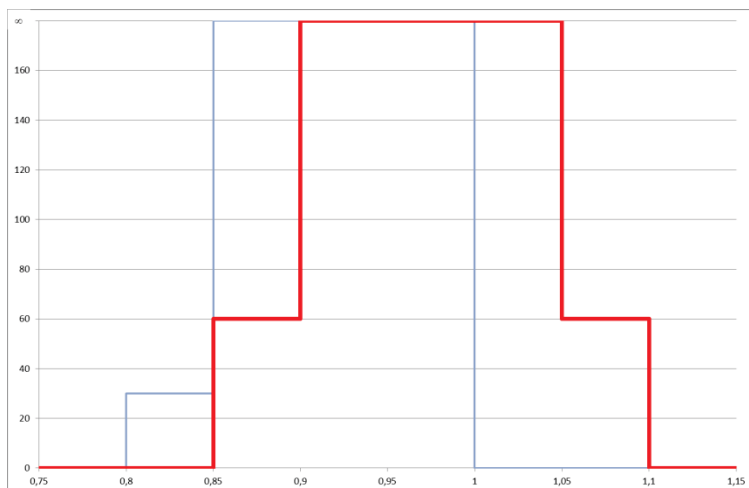

Figure 12 – Poland

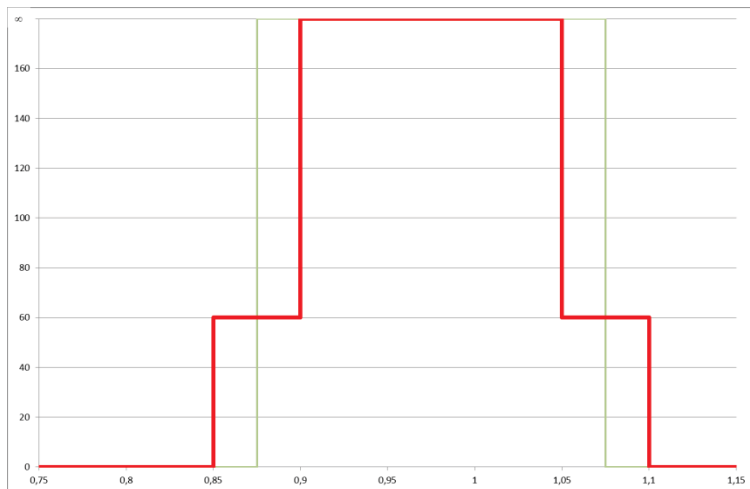

Figure 13 – Italy

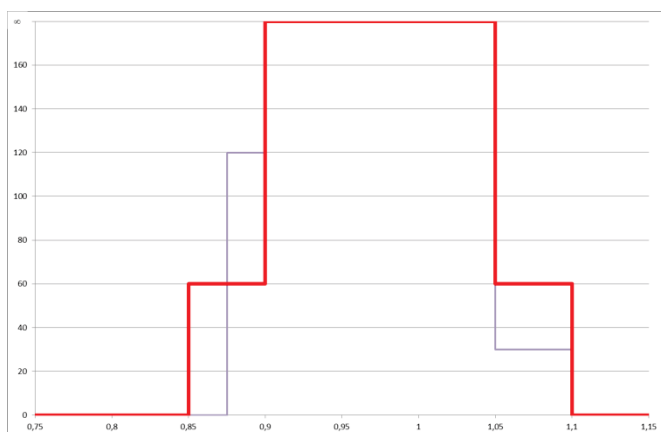

Figure 14 – Germany

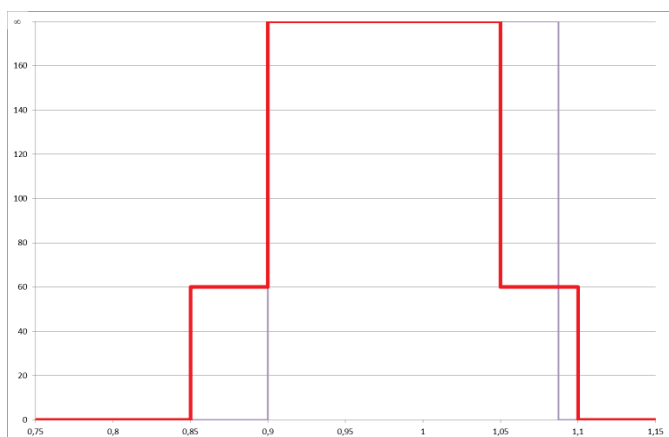

Figure 15 - Spain

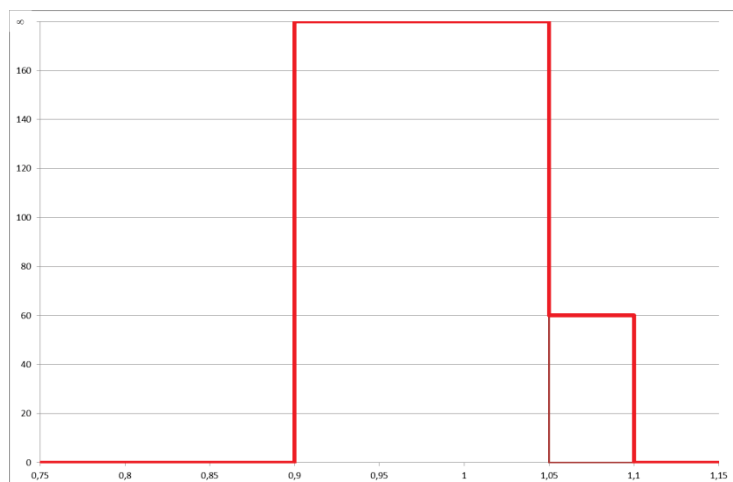

Figure 16 – Norway

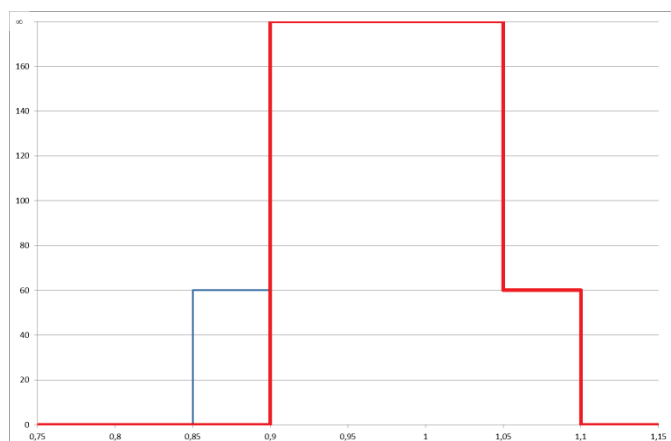

Figure 17 - Sweden-Finland

Unlimited time operation

NC RfG requires an unlimited time operation capability for 0.9 to 1.05 p.u. which is broadly in line with most present transmission grid codes.

For the smaller GB and the Irish system, the NC RfG voltage ranges for unlimited time operation are also aligned with present grid codes.

Limited time operation

The duration of the time limited operation is not standardised and can be different depending on the type of generator as well as the needs of the local system. Without any additional equipment a generator should stay connected to the grid within the variation of $\pm 8\%$ of its rated voltage. It should be noted that the voltage range

defined in standard EN 60034-1 refers to the generator voltage in contrast to this network code where the voltage range is defined at the Connection Point.

For the low voltage range the NC RfG ranges do not go more onerous than the present most stringent voltage range requirements across Europe. Requirements (by code or contractual arrangement) down to 0.85 p.u. exist nowadays in e.g. Poland, Hungary, Denmark and Sweden.

For the high voltage range, the NC RfG allows for connections between 110 and 300kV in Continental Europe to go to 1.15p.u. for a limited period of 20 minutes. Longer time periods are to be dealt with at national level while respecting the provisions of Art 4(3). The time period of 20 minutes up to 1.15 p.u. is in line with an extensive report on testing of high voltage equipment published by Cigre⁷ and which forms the basis of many TSO operational rules nowadays.

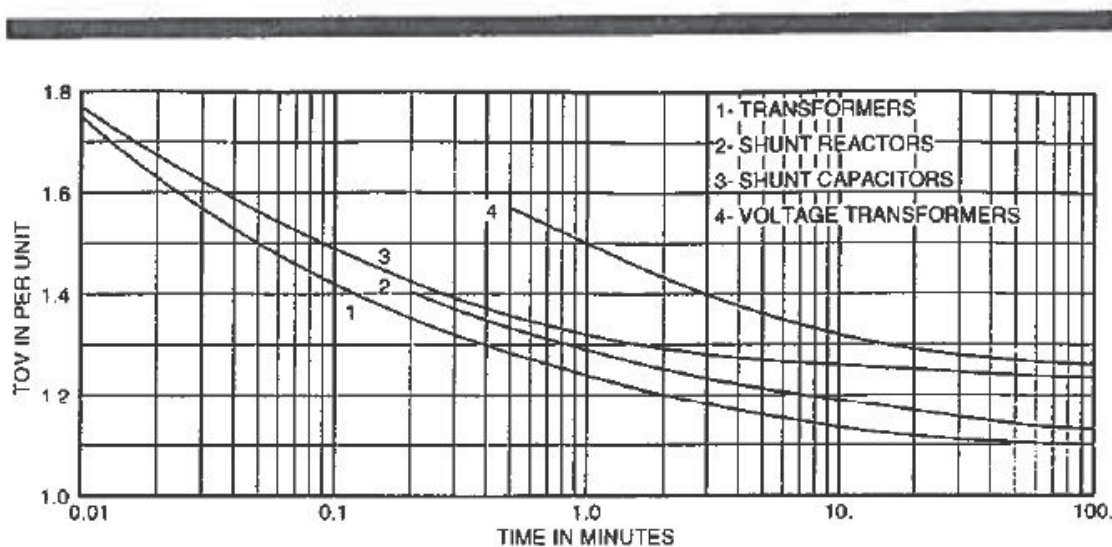

Figure 1. Caractéristiques de tenue aux surtensions temporaires pour les matériels de puissance.

Figure 1. Withstand TOV characteristics for power equipment.

FIGURE 18 - TESTING RESULTS ON TEMPORARY OVERVOLTAGE WITHSTAND CAPABILITIES OF EHV EQUIPMENT (CIGRE, 1999)

The following explanation is quoted from the FAQ on voltage ranges and gives more insight on the relation between present industry standards on voltage ranges and the NC RfG voltage range requirements which apply at the connection point:

Between the generator terminals and the Connection Point there will be at least one transformer and its parameter has essential influence on the capability of the Generating Unit to operate at voltages below and above rated generator voltage. Therefore, to minimize adverse effects on the generator from operation outside the nominal parameters (e.g. reduction in life of the generator) additional countermeasures can be taken. To meet the voltage range as required by the network code and to increase the permissible range of Generating Unit operation without negative effect on the grid voltage, on-load tap changers can be used. It makes the voltage range requirements compatible for the Generating Unit and this is also the case for auxiliaries, as auxiliary and

⁷ WG 33.10, Temporary Overvoltages: Withstand Characteristics of Extra High Voltage Equipment, Electra No.179 August 1998, pp. 39-45

standby transformers can also be equipped with on-load tap changers . Note that according to EN50160 standards under normal operating conditions voltage variations should not exceed $\pm 10\%$, and for remote users $+10\%/-15\%$ of nominal voltage (refer to medium voltage) unless otherwise agreed with the grid users. Thus the voltage requirements defined in EN60034-1 standard cannot be treated as binding at the Connection Point for power Generating Units, nor can it restrict the Network Operators to define Generating Unit requirements (as a whole and not only the generator) to ensure system security. From this point of view these voltage range requirements are not in contradiction with IEC standards.

The wide voltage ranges of the Generating Unit operations are very important during "normal" operation to ensure the technical capability of a Generating Unit to retain synchronous operation and support the system when local voltage problems occur (e.g. to avoid voltage collapse). Across Europe, tripping of generation units from the meshed network to protect plant and equipment and to prepare to contribute to the restoration process is permitted if extreme voltage drops occur. In practice, the setting of these under voltage protections in terms of nominal grid voltage and time delay should be agreed with the Network Operators.

A wide voltage range of Generating Units is furthermore highly desired during the system restoration process when extreme voltage conditions may occur, (e.g. during charging of long lines).

Conclusion

- **The voltage ranges in present European grid codes vary substantially.**
- **The NC RfG voltage range requirements are not the most onerous, nor the present least onerous.**
- **The most onerous requirement on high voltage excursions at the connection point (below 300kV) in Continental Europe is supported by studies on testing performed by Cigre and which reflects reality in many operational rules nowadays.**

6 FAULT-RIDE-THROUGH

Note that an extensive explanation on the interpretation of the Fault-Ride-Through (FRT) requirements and the means for testing compliance to it, is also provided in the „NC RfG – Frequently Asked Questions“ as FAQ 24

6.1 SCOPE

This Section on FRT requirements focuses mainly on smaller generators of Type B, and to some extent Type C. The reason for this narrow focus is explained by the classification of FRT requirements as non-exhaustive covered in section 6.5 as well as the content of sections 6.6 and 6.7 covering an overview of existing FRT requirements which demonstrates that at Transmission level the NC RfG requirements are overall compatible with the existing national requirements (in Grid Codes). The national choices broadly allow existing requirements to be continued with only minor changes.

The basic purpose of the FRT capability is explained in section 6.2 together with the controversial aspect of the 250ms fault clearance time for synchronous Power Generating Modules.

The above mentioned overview does not fully cover the smaller generators. Time has not permitted a specific detailed survey on this issue for smaller generators with the DSOs.

6.2 WHAT IS THE FRT CAPABILITY ABOUT AND WHY IS THERE A THE POSSIBILITY FOR SUCH A LONG TIME AS 250MS?

Electrical faults (short circuits) do occur on the electrical networks. It is critically important that the overall system can ride through such occurrences with minimum disturbance to users and as such also for the market. If faults occur on the connection of a generator, this generator needs to be removed from the system; it has to be tripped. However, it is critically important that other generators which are affected by a temporary reduction in voltage until the fault is cleared do not also trip. If they also trip, the total generation loss may be so large that the consequent frequency drop may not be adequately managed and widespread demand disconnection may occur. These consequences can affect an entire synchronous area.

Large synchronous generators have for many decades been able to ride through faults on the system. This has at least been the case for faults cleared quickly (may be within 100-150ms), as is normally the case. A fault in 2003 in Sweden was not cleared in the normal time due a further failure of equipment. This resulted in widespread black-out covering Southern Sweden and part of Denmark including Copenhagen. Based on this adverse experience a political decision was made to invest in further resilience of the network to withstand even such a double contingency. This further investment in faster protection systems has resulted in a capability of generators being capable of riding through faults even with a second contingency such as a circuit breaker failing. In Sweden (Nordic countries) this capability is specifically limited to otherwise normal or advantageous conditions prior to the fault. Within the Nordic system 250ms FRT capability is therefore specified, with initial conditions which have been practical to achieve for large generators. The NC RfG will not 'turn back' this investment by a European requirement forcing a shorter FRT fault clearance time value, e.g. 150ms which is a typical FRT choice elsewhere.

Elsewhere such additional investments in extremely fast protection systems (to cover failures of circuit breakers during faults) are not common. However, different practices of requiring the generators to ride through faults in more adverse starting positions than in the Nordic countries may have been chosen instead. These adverse conditions (e.g. absorbing reactive power rather than generating reactive power) with a much shorter time (e.g. 150ms) may be similarly challenging for the generators, but still achievable. Instead of harmonising these differences, the NC RfG leaves a significant national freedom to define both the fault duration as well as assumptions about the initial conditions. This has resulted in Power Generating Facility Owners and manufacturers fearing that the most challenging combination of these two aspects would be applied. ENTSO-E and its members know that this would result in an unrealistic requirement which would not allow large generators to connect. There is therefore no intent to select this worst combination.

6.3 WHY SHOULD FRT REQUIREMENTS BE EXTENDED TO SMALLER UNITS?

In the early stages of introducing small units of RES, often connected deeply embedded in the distribution systems, the industry allowed these units to trip when there was a system disturbance. However, as the volume of RES which could all be tripping simultaneously from a single transmission system fault grew, it became essential to require the RES units to ride through the faults. Initially this was achieved for the larger RES units, but gradually mass tripping of smaller units becomes a risk for system security, with a potential widespread demand disconnection through after a large drop in system frequency.

A high level review of the need of the power systems in respect of extending technical requirements down to smaller sizes of generators is covered in the ENTSO-E paper “Network Code “Requirements for Generators” in view of the future European electricity system and the Third Package network codes.”

Four extracts from this document are specifically relevant in this context:

- Much of the present electricity system was primarily designed to supply electricity from large dispatchable and synchronous generation units with abilities to both balance the active power and supply the necessary ancillary services to ensure system stability. **The future generation system will however be based on a vast number of distributed and power electronics based generators with a variable and only partly dispatchable generation based on RES.**
- **RES is to a significant extent connected to the distribution network.** As a consequence the DSOs have to increase their role in facilitating the connection and integration of RES while at the same time they have to guarantee their customers a high level of power quality.
- The overall NC RfG structure and specific requirements are based on the intensive experience from conventional power plants and stakeholders input on the cost elements (without insofar having precise commercially confidential data). The outcome is a proportional allocation of the requirements for future generator throughout Europe on a level playing field.
- Small levels of RES generation (geographically dispersed) are unlikely to significantly impact the secure operation of the system should they shut down simultaneously. However, as the levels of RES increase it is of increasing importance that **a single system event should not result in the large scale shut down**

generation. RES generation needs to be resilient to system faults staying connected (and generating) during the initial voltage transients (as conventional generation does today). Since a cost efficient FRT functionality is embedded deeply in the power electronics of generation units, with a long development period, that capability has to be identified today to meet future operational requirements

ENTSO-E believes there is a need for even the smallest units (Type A) not to trip in vast numbers simultaneously in response to a single fault at the highest voltage level. ENTSO-E would therefore like to have this capability established universally. However, after extensive discussions with stakeholders, a balance is found that introducing this requirement, for which demonstrating compliance could be particularly resource intensive, may not be practical for the vast numbers of Type A generators. The requirement is therefore not introduced until Type B. The decision to leave Type A out of FRT requirements may need to be reviewed in the future in light of further experience. ENTSO-E encourages manufacturers even for Type A to follow the same principle of designing the capability to ride through faults where practical even for the smallest generators.

6.4 ACER'S FRAMEWORK GUIDELINES ON FRT

ACER's FWGL states in the fourth paragraph of section 2.1.2:

*"The network code(s) shall set out the **necessary requirements for protection and fault-ride through capability** with particular focus on distributed generation because of its increasing importance and contribution to meeting demand. These requirements shall aim at **avoiding** e.g. a large disturbance in the transmission network resulting in **mass tripping of distributed generation units**."*

6.5 CLASSIFICATION OF FRT RELATED REQUIREMENTS

A number of NC RfG requirements are relevant to FRT capabilities. These covers the following topics:

1. Synchronous Power Generating Modules
 - a. Voltage against time below 110kV
 - b. Voltage against time for 110kV & above
2. Power Park Modules
 - a. Voltage against time below 110kV
 - b. Voltage against time for 110kV & above
 - c. Priority of real or reactive power
 - d. Post fault active power recovery
 - e. Reactive current injection

All the respective requirements covered are non-exhaustive, i.e. further details are to be provided at national level.

6.6 HOW DO THE REQUIREMENTS OF NC RfG RELATE TO PRESENT REQUIREMENTS THROUGHOUT EUROPE?

A direct comparison is not practical, because the basis of the requirements including the location of where the requirement applies varies greatly.

- In some countries this is defined at the generator terminals, in some countries at the Connection Point and in some at the nearest EHV point.
- Several countries have not yet established requirements for FRT in their grid code. This tends to apply for countries with only modest amount of RES installations so far.
- For PPMs connected at 110 kV and above there is generally close alignment with NC RfG.
- For medium size (Types B+ C) PPMs there is mostly alignment where covered. The requirement is not always covered at the lower end
- For synchronous generators the FRT requirement is not always covered explicitly as the capability may be assumed inherently present. Where covered, the requirements are broadly in line with those of NC RfG.

Conclusion

- **Fault-Ride-Through requirements are becoming increasingly critical in power systems with increasing amounts of PPMs and dispersed generation.**
- **The NC RfG requirements on FRT cover presently prescribed FRT requirements across Europe.**
- **The NC RfG gives a European framework within which many specifications are still to be taken at national level. A combination of all most onerous parameter values is not in line with the principle of principle of optimisation between the highest overall efficiency and lowest total cost for all involved parties.**

6.7 EXTRACTS FROM NATIONAL CODES

This section provides a selected set of extracts from present transmission grid codes on the topic of FRT. This illustrates the wide variety in which these are formulated nowadays. Due to these variations it is not possible to provide an objective comparison by simply compiling a number of voltage-against-time curves in one figure.

6.7.1 AUSTRIA

Generating units connected ≥ 110 kV:

- TOR B, 6.4.10: a distinction between near-to-generator faults and far-from-generator faults is made:
- near-to-generator faults: fault time periods ≤ 150 ms (until the fault is fully cleared) shall not cause any instability or disconnection of the generating unit
- far-from-generator faults: even for fault time periods up to 5 s the generating units shall not trip onto their auxiliary supplies nor disconnect from the grid

Generating units connected < 110 kV:

- TOR D4, 8.1.2: Depending on voltage dips, generating units shall stay connected for certain time periods.
- For voltage dips to between 1 pu and 0.7 pu: generating units shall stay connected
- For voltage dips to between 0.7 pu and 0.3 pu: generating units shall stay connected for at least 0.7 s

For voltage dips to < 0.3 pu: generating units shall stay connected for at least 150 ms, if technically not feasible a disconnection shall be allowed in accordance with the network operator.

- No specific pre-fault conditions are defined in the national grid code

6.7.2 FINLAND

Deep voltage transient (FRT) - power units connected to the 400 kV, 220 kV or 110 kV voltage level.

The power units with their auxiliary systems shall be designed so that they can withstand the following suggestive grid voltage variations without disconnection from the grid (Figure):

- step reduction of the grid voltage to 0% lasting for 0.25 seconds,
- followed by a linear increase in grid voltage from 25% to 90% in 0.5 seconds,
- followed by a constant grid voltage of 90%.

Only a small power reduction is accepted.

- HV grid voltage 1 p.u.: Generator operating at nominal real power (PN).

Reactive power output of the generator shall be such, that measured at the HV terminals of the step-up transformer, the power plant does not produce or consume reactive power to/from HV grid (basically, unit operated somewhat overexcited).

6.7.3 HUNGARY

FRT curve for generating units except power park modules:

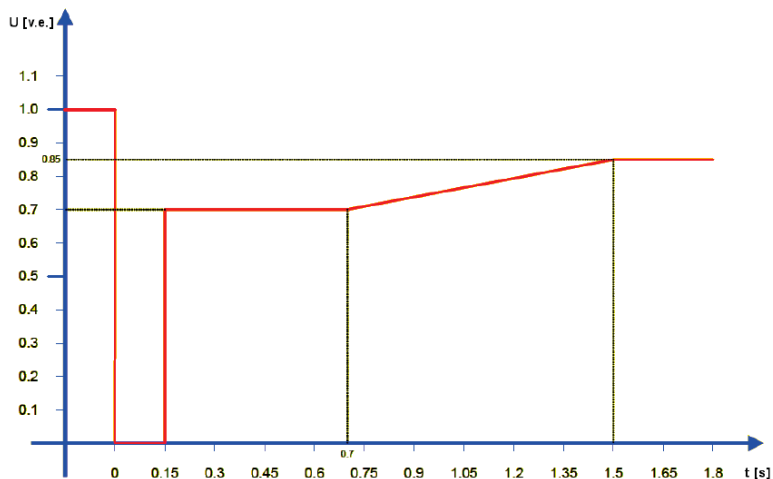

FRT curve for power park modules:

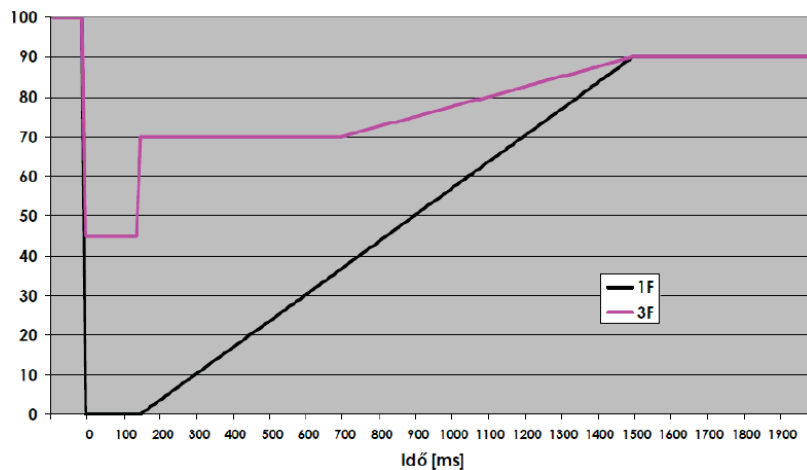

1F: single line-to-ground fault

3F: three phase fault

6.7.4 SWITZERLAND

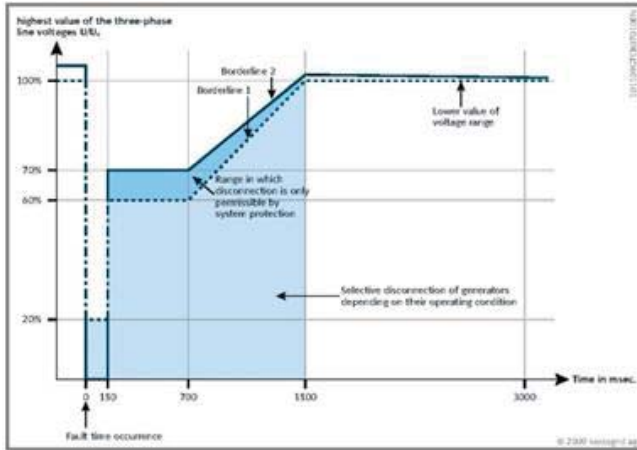

Figure 7: Borderline showing the permitted operating voltage at the connection point

6.7.5 ITALY

For Wind PPM installed in Sardinia and Sicily, the following FRT profile applies:

8.2. Insensibilità agli abbassamenti della tensione

Durante un corto circuito nella rete è inevitabile una generale riduzione delle tensioni in tutti i nodi elettrici. In caso di guasto esterno alla centrale la stessa deve essere in grado di mantenere la connessione con la rete. È richiesto che le centrali eoliche mantengano il proprio stato di funzionamento e che gli aerogeneratori rimangano connessi alla rete qualora i valori della durata e della riduzione della tensione, tipici dei guasti in rete, misurati nel punto di connessione della centrale, si mantengano nella zona superiore alla curva di Figura 1. Si osservi che l'area al di sotto della linea spezzata indica le coppie di valori di tensione e di tempo in cui la disconnessione non è richiesta, ma è solo ammessa.



Figura 1: Valori della tensione a cui, in seguito ad un guasto in rete, la centrale eolica deve mantenere la connessione.

For PV PPM, the following FRT profile applies:

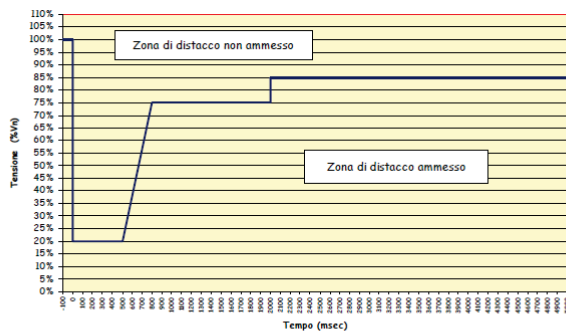

figura 6 – Caratteristica tensione-durata riferita al punto di connessione

For embedded generation, the following FRT profile applies:

7.2.1. INSENSIBILITA' AGLI ABBASSAMENTI DI TENSIONE

Gli impianti di produzione statici connessi alle reti MT e BT di potenza nominale ≥ 6 kVA devono essere in grado di non disconnettersi istantaneamente durante l'abbassamento di tensione conseguente a un qualsiasi tipo di cortocircuito esterno, monofase o polifase (con e senza terra).

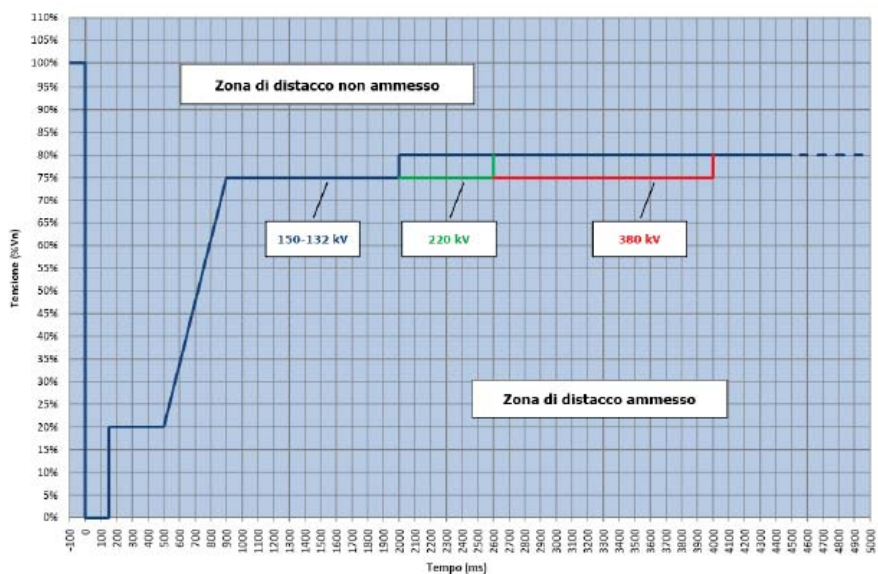
In particolare deve essere garantita la connessione alla rete nella zona al di sopra e lungo i punti della caratteristica (V - t) indicata, dove la tensione V è la tensione ai morsetti dell'impianto di produzione. I valori indicati sono in percentuale della tensione nominale.

Nell'intervallo di durata dell'abbassamento di tensione l'impianto dovrà rimanere connesso alla rete, anche se non garantirà il valore di potenza immessa nell'istante immediatamente precedente al guasto. Al ristabilirsi delle normali condizioni di funzionamento³ la potenza immessa in rete dovrà tornare ad un valore prossimo a quello precedente il guasto, in un tempo non superiore a 200 ms.



figura 2 – LVRFT (tratta da norma CEI 0-21)

For Synchronous Generators, this type requirement is presently not covered by our grid code

6.7.6 POLAND

Type D units

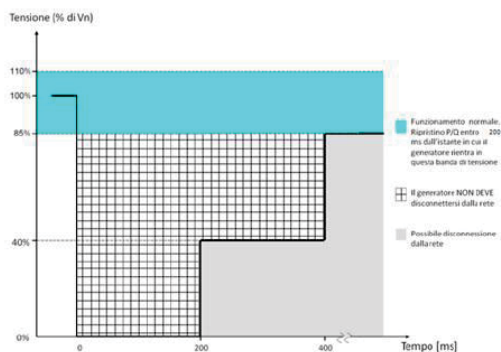
- Units must stay connected to the grid when the short circuit is cleared with time:
 - $t = 120$ ms for 220 kV and 400 kV grid,
 - $t = 150$ ms for 110 kV grid.
- FRT curve is not defined in the Grid Code.

For wind farms:

- Wind farm must stay connected to the grid in area above the curve shown in figure (under this text)

Pre-fault conditions for type C and D units are not defined in grid code.

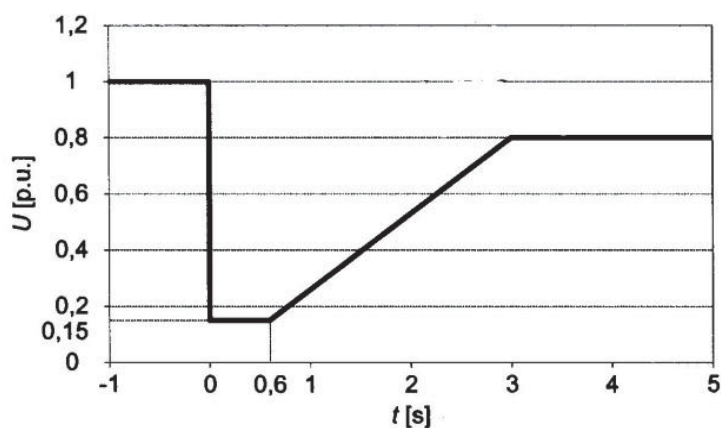

6.7.7 SPAIN

Ministry Resolution Operational procedure 12.3 (2006):

- Requirement applies to all the wind farms, existing and new.
- FRT profile is given below:

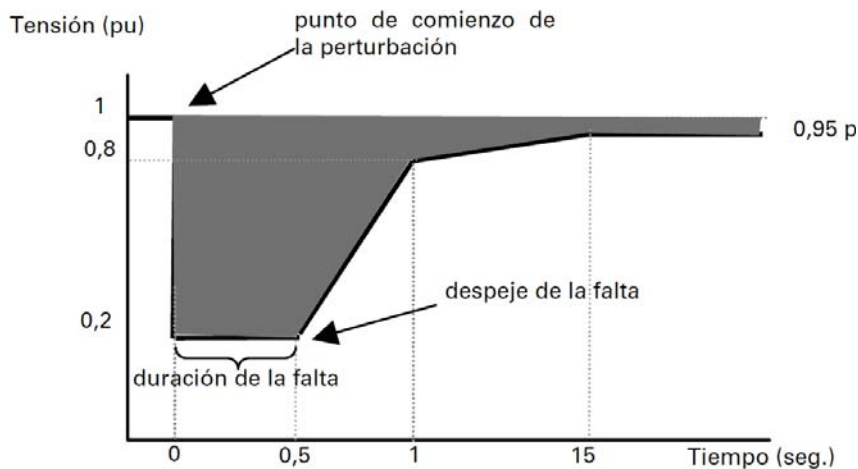

- There are more than 21 GW of wind energy capacity connected to the Spanish power system. More than 95% of the total capacity complies with the above FRT profile
- About 14GW of existing windfarms were retrofitted to fulfill the FRT requirement
- A task force was launched with the purpose of developing the “Procedure for verification, validation and certification of the requirements of the PO 12.3 on the response of wind farms in the event of voltage dips” (PVVC 12.3)
- Accredited laboratories and certification entities follow the PVVC 12.3 to certify that wind power facilities comply with PO 12.3
- Regarding pre-fault conditions, The power system recovery times represented in the above figure are, in general, verified in the case of the capacity of a generation facility connected to the grid not exceed 5% of the grid short circuit power at this connection point.

6.7.8 SWEDEN

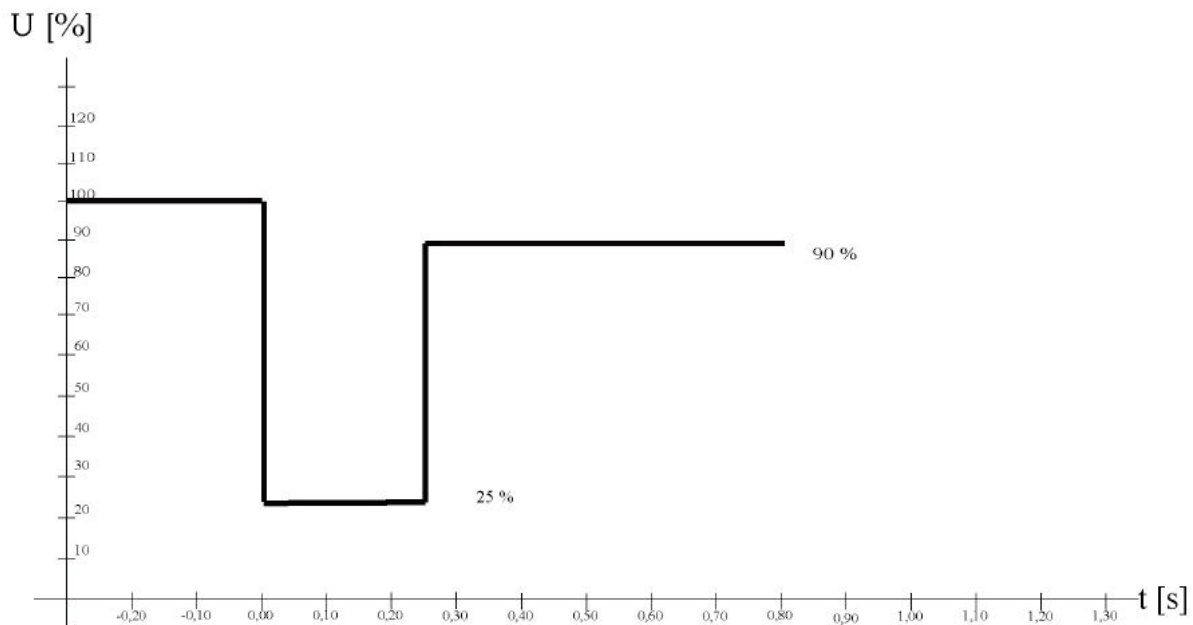

The figure above shows the Swedish FRT requirement for all power plant facilities (not generators) up to 50 MW for hydro and up to 100 MW for all other types of power plant facilities. The voltage curve shall be applied at the nearest meshed transmission point (which is not necessarily the point of connection).

pre-fault conditions:

- Intact and highly loaded grid before and after fault (no weakening of the grid after fault).
- Generators lightly overexcited pre fault (near zero exchange of reactive power with the grid pre-fault).

6.7.9 NORWAY

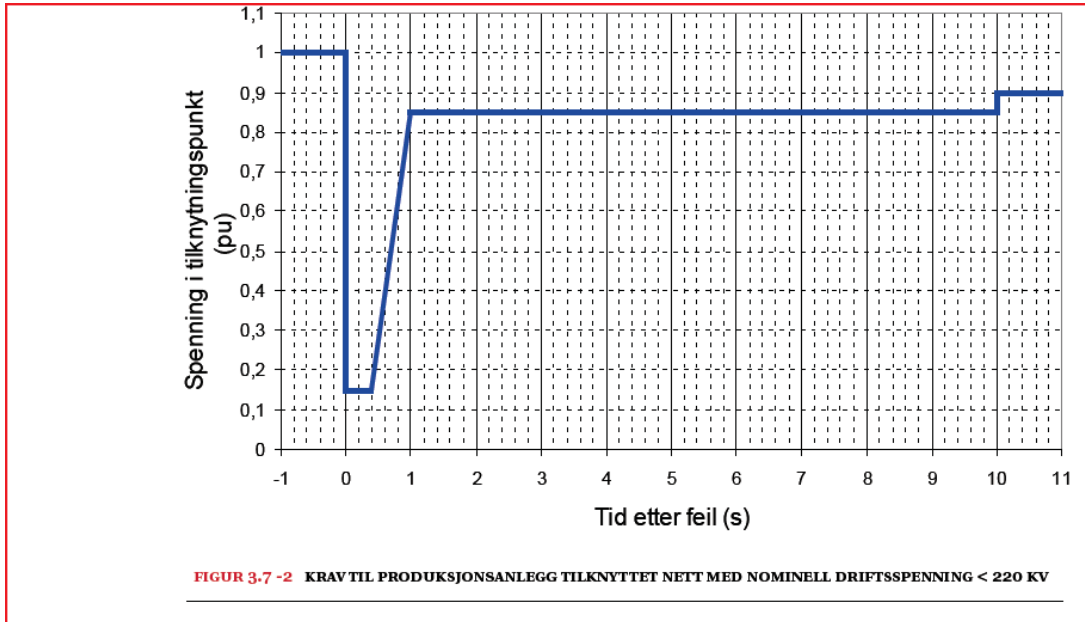

6.7.10 PORTUGAL

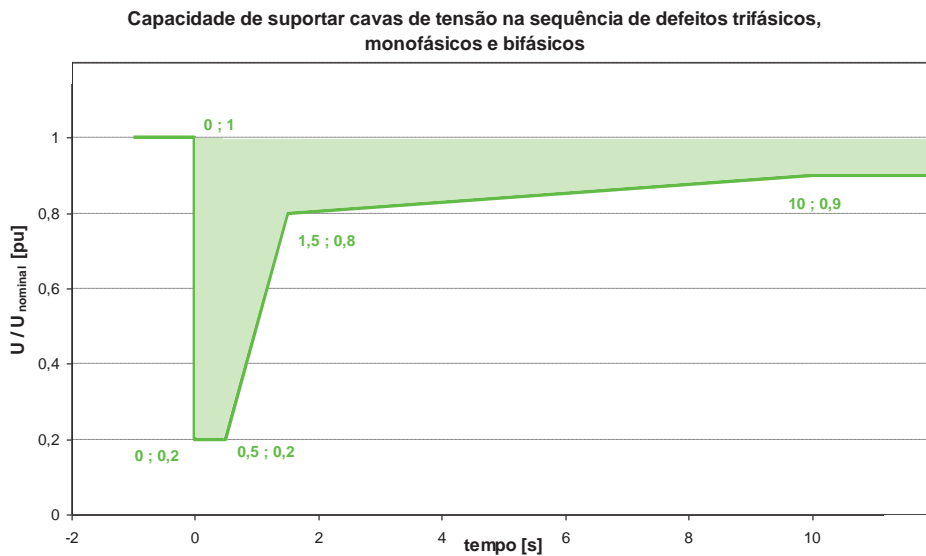

With regard to Fault Ride Through capability, transmission (all) and Distribution (maximum capacity above 6 MVA) connected Power Park Modules (Wind), shall, according to the respective Transmission and Distribution Grid Code, remain connected to the grid during faults (symmetrical or unsymmetrical) when voltage is above the following curve. According to the Transmission Grid Code, there are no specific pre-fault conditions for the FRT requirement.

6.7.11 GREAT BRITAIN

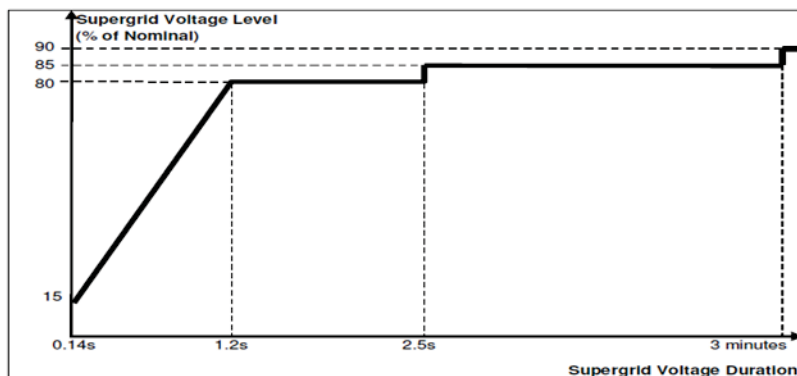

Figure 5

The fault ride through requirements are defined in CC.6.3.15 of the GB Grid Code. The whole requirement is not defined by a voltage duration curve but in summary the requirements are as follows but ENTSO-E representatives are recommended to refer to CC.6.3.15 of the Grid Code.

1) For faults up to 140ms in duration

Generators (including Power Park Modules) are required to remain connected and stable for any balanced or unbalanced fault (of up to 140ms) on the High Voltage Transmission Network operating at voltages of 200kV or greater.

During the period of the fault each generating unit should generate maximum reactive current to the transmission system without exceeding the transient rating of the Generating Unit

Within 0.5 seconds of fault clearance, the Active Power output of the Generating Unit shall be restored to at least 90% of the level immediately before inception of the fault

2) For Faults in excess of 140ms in duration

Generators (including Power Park Modules) are required to remain connected and stable for any balanced voltage dip on the High Voltage Transmission Network operating at voltages of 200kV or greater anywhere on or above the heavy black line shown in the Figure below.

3) During the period of the voltage dip, each Generating Unit should provide active power output at least in proportion to the retained balanced voltage on the Transmission System (unless there has been a reduction in the active power source – in the case of a Power Park Module) and shall generate maximum reactive current without exceeding the transient rating limits of the Generating Unit.

In addition, each Generating shall be required to restore at least 90% of the pre-fault Active Power output ((unless there has been a reduction in the active power source – in the case of a Power Park Module) within 1 second of restoration of the voltage at the Connection Point.

6.7.12 BELGIUM

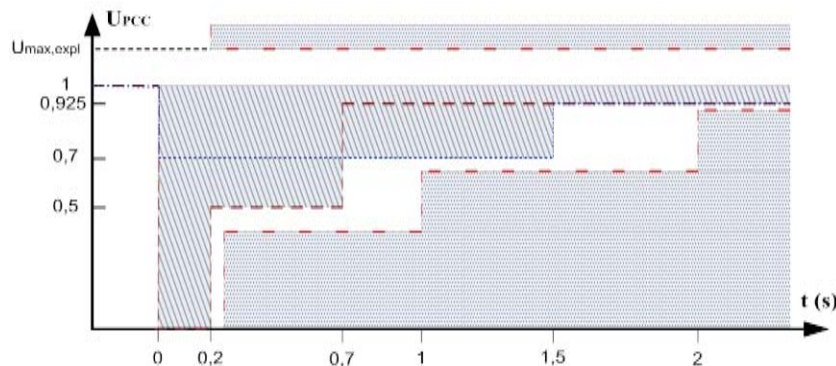

For all type of units at voltage levels 30kV and over, two FRT profiles are applied a fault profile (brown dashed curve) and a dip profile (blue dotted curve). These profiles are defined with respect to the normal operating voltage at the connection point. They apply for symmetrical faults.

Note: For all type of units at voltage levels 30kV to 110kV, the unit is required to disconnect in the shaded areas delimited by the red dash-dotted lines to avoid the creation of an undesired isolated network.

During the compliance validation process, the FRT requirements have to be tested with the following pre-fault conditions:

- Minimum short-circuit power at the connection point
- $U = 1$ pu at the connection point
- Machine operating point : $P=P_{nom}$ and $Q=0$

7 REACTIVE POWER CAPABILITY

The NC RfG addresses several requirements on reactive power capabilities:

Different types of networks (e.g. distribution or transmission purpose), different network topologies (degree of network meshing) and characteristics (ratio of infeed and consumption) need different ranges of reactive power. The provision of reactive power at a certain point in the network strongly depends on the local needs which are described in the sentence before. For instance, highly meshed and/or heavily loaded networks need more lagging reactive power (production), whereas remote networks with modest power flows and low consumption need more leading reactive power (consumption) in order to keep the network voltage within the permitted range.

For this reason, the requirements are formulated as a general framework, using an inner envelope with fixed dimensions within which the RNO defines a $U - Q/P_{max}$ curve. As an additional degree of freedom this inner envelope can be moved within a fixed outer envelope.

For PPMs a similar requirement is given for reactive power capability below maximum active power output, aiming mainly at guaranteeing a sufficient and reliable provision of reactive power support at low active power output and to avoid step changes in case of sudden wind sags (wind generation) or clouds (PV).

This formulation of inner/outer envelopes allows broadly speaking that most present grid code requirements on reactive power capabilities are covered by the NC RfG provisions. Minor deviations may exist, mostly related to technology specificities or voltage/capacity thresholds.

Below, some examples are given of how present grid code requirements fit into this envelop formulation.

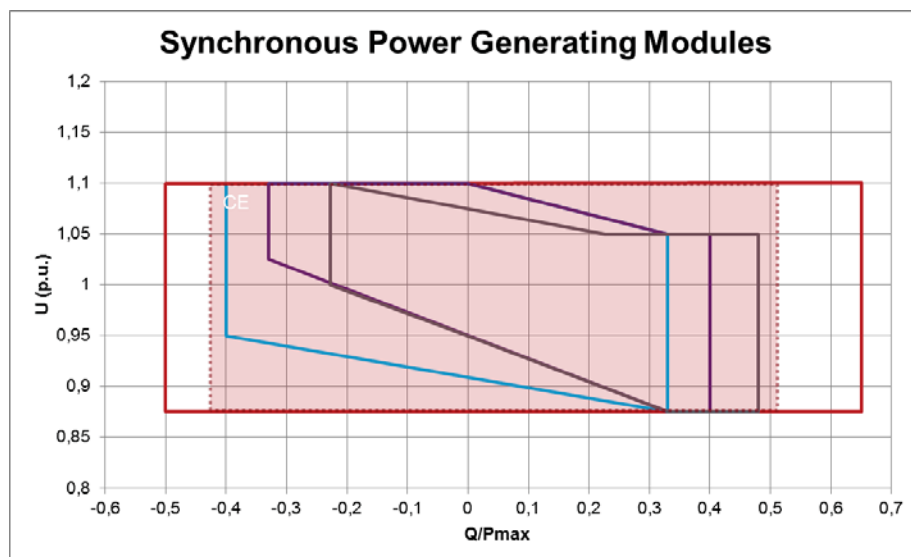

FIGURE 19 - GERMAN TRANSMISSION GRID CODE ON SYNCHRONOUS GENERATORS (3 OPTIONS)

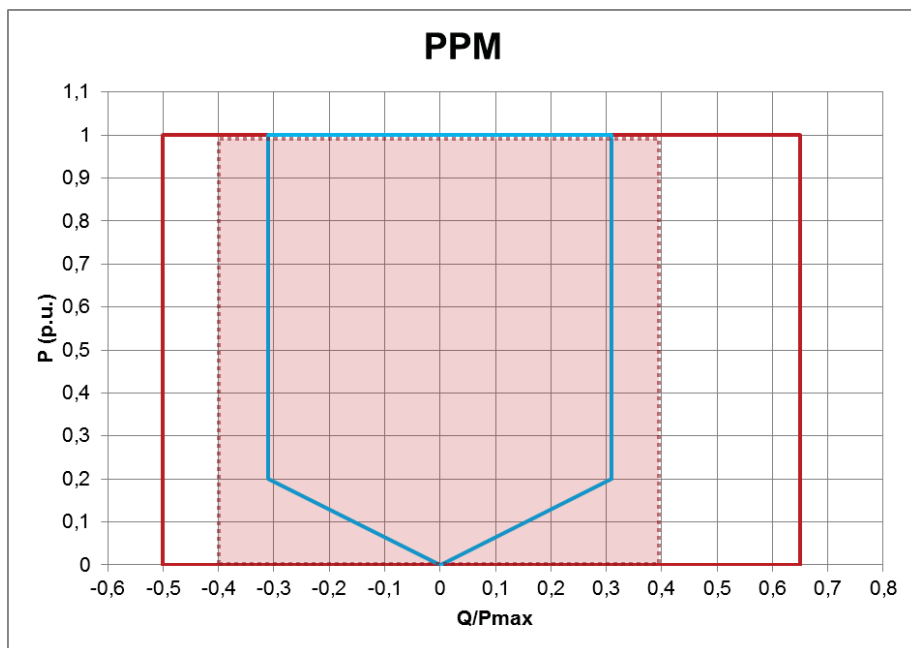

FIGURE 20 - GERMAN TRANSMISSION GRID CODE ON PPMs

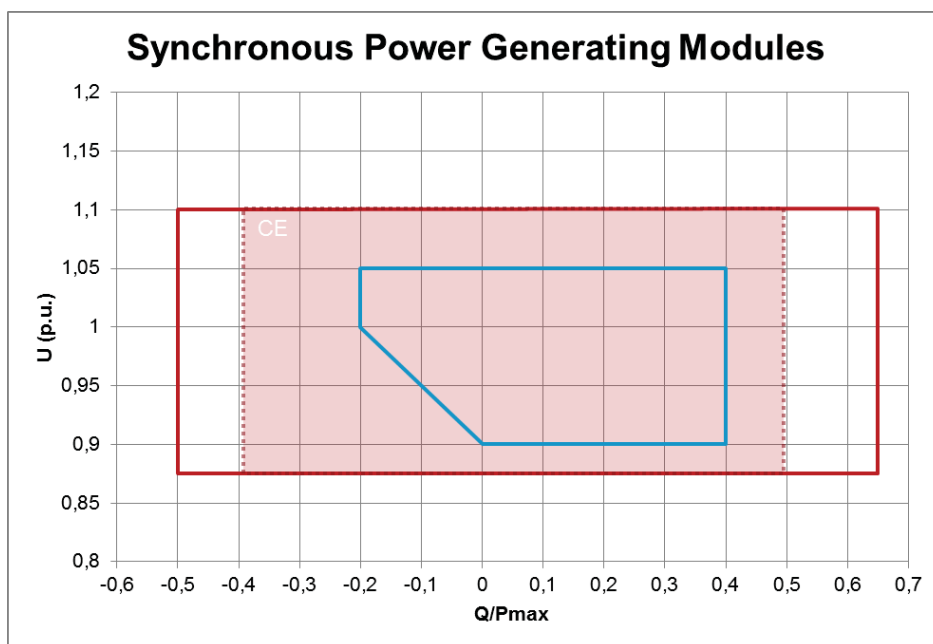

FIGURE 21 - DANISH TRANSMISSION GRID CODE ON SYNCHRONOUS GENERATORS

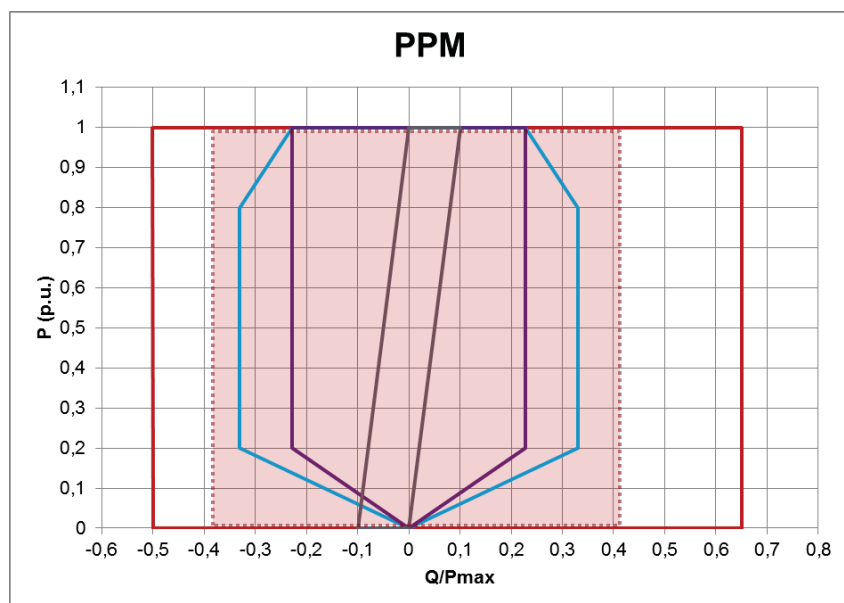

FIGURE 22 - DANISH TRANSMISSION GRID CODE ON PPMS

An often raised concern by manufacturers and Power Generating Facility Owners is that the lower left / upper right corners of the outer envelope are too onerous, e.g. imposing a high cost in terms of OLTC tap changers or additional reactive support devices. Similarly as with the concern on FRT requirement ENTSO-E stresses that in the national implementation of any NC RfG requirement the provisions of Art 4(3) will be respected and a techno-economic optimum needs to be found.

In this context it is to be noted that some reactive power capability requirements today do not use a $U - Q/P_{max}$ formulation, but rather require delivery of reactive power within a power factor range, subject to certain boundary conditions⁸.

Taking into account potential future needs to cope with a different (more dispersed) generation portfolio, there is no clear guidance on how to constrain the envelope formulation further, e.g. by explicitly cutting the lower left and upper right corners.

⁸ Great Britain: The Reactive Capability for Generators is specified in CC.6.3.2 of the GB Grid Code. For Synchronous Generators, no Q/P_{max} curve is specified but at Rated MW output a Synchronous Generator must be capable of continuous operation at any point between 0.85 Power Factor lag and 0.95 Power Factor lead at the Generating Unit Terminals. At maximum active power the lagging requirement is permitted to be reduced to 0.9 Power Factor.

Conclusion

- The reactive power capability requirements provide a general framework for national implementations, which covers a wide variety of requirements applicable today.
- Present reactive power capability requirements have various formulations, either by U-Q/Pmax curves or power factor ranges.
- The general framework is developed to not restrict future needs in coping with potential changed generation portfolios.
- The real justification of a reactive power capability implementation needs to be taken at national level while respecting the provisions of Art 4(3).